

General Specifications

ROTAMASS Total Insight Coriolis Mass Flow and Density Meter Hygienic



GS 01U10B06-00EN-R



Scope of application

- Precise flow rate measurement of fluids and gases, multi-phase fluids and fluids with specific gas content using the Coriolis principle.
- Direct measurement of mass flow and density independent of the fluid's physical properties, such as density, viscosity and homogeneity
- Concentration measurement of solutions, suspensions and emulsions
- Fluid temperatures of $-70 - 140\text{ }^{\circ}\text{C}$ ($-94 - 284\text{ }^{\circ}\text{F}$)
- Threaded hygienic connections and clamp connections, up to three nominal diameters per device meter size
- 3-A compliant, EHEDG certified and polished measuring tubes in 1.4404/316L
- Connection to common process control systems, such as via HART, Modbus or PROFIBUS PA
- Hazardous area approvals: IECEx, ATEX, FM (USA/Canada), NEPSI, INMETRO, PESO, EAC, Taiwan Safety Label, Korea Ex, Japan Ex
- Safety-related applications: PED per AD 2000 Code, SIL 2, secondary containment up to 49 bar

Advantages and benefits

- Inline measurement of several process variables, such as mass, density and temperature
- Advanced functions like Batching and Viscosity function to avoid external dedicated flow computer.
- Adapterless installation due to multi-size connection concept
- No straight pipe runs at inlet or outlet required
- Fast and uncomplicated commissioning and operation of the flow meter
- Maintenance-free operation
- Functions that can be activated subsequently (Features on Demand)
- Total Health Check (diagnostic function): Self-monitoring of the entire flow meter, including accuracy
- Maximum accuracy due to calibration facility accredited according to ISO/IEC 17025 (for option K5)
- Self-draining installation
- Vibration-resistant due to counterbalanced double-tube measurement system

Table of contents

1	Introduction	5
1.1	Applicable documents.....	5
1.2	Product overview	6
2	Measuring principle and flow meter design	7
2.1	Measuring principle.....	7
2.2	Flow meter	9
3	Application and measuring ranges	12
3.1	Measured quantities	12
3.2	Measuring range overview.....	12
3.3	Mass flow	13
3.4	Volume flow	13
3.5	Pressure loss	13
3.6	Density.....	14
3.7	Temperature	14
4	Accuracy	15
4.1	Overview	15
4.2	Zero point stability of the mass flow.....	16
4.3	Mass flow accuracy	16
4.3.1	Sample calculation for liquids	18
4.3.2	Sample calculation for gases	19
4.4	Accuracy of density.....	20
4.4.1	For liquids	20
4.4.2	For gases	20
4.5	Accuracy of mass flow and density according to the model code	21
4.5.1	For liquids	21
4.5.2	For gases	21
4.6	Volume flow accuracy.....	22
4.6.1	For liquids	22
4.6.2	For gases	22
4.7	Accuracy of temperature.....	23
4.8	Repeatability	23
4.9	Calibration conditions	24
4.9.1	Mass flow calibration and density adjustment.....	24
4.9.2	Density calibration.....	24
4.10	Process pressure effect	24
4.11	Process fluid temperature effect	25
5	Operating conditions	26
5.1	Location and position of installation.....	26
5.1.1	Sensor installation position	26
5.2	Installation instructions	27
5.3	Process conditions.....	28
5.3.1	Process fluid temperature range.....	28
5.3.2	Density	28
5.3.3	Pressure.....	29

5.3.4	Mass flow	31
5.3.5	Effect of temperature on accuracy	31
5.3.6	Secondary containment	31
5.4	Ambient conditions	32
5.4.1	Allowed ambient temperature for sensor	33
5.4.2	Temperature specification in hazardous areas	35
6	Mechanical specification	42
6.1	Design.....	42
6.2	Material	43
6.2.1	Material wetted parts.....	43
6.2.2	Non-wetted parts.....	43
6.3	Process connections, dimensions and weights of sensor	44
6.4	Transmitter dimensions and weights	47
7	Transmitter specification	49
7.1	HART and Modbus	50
7.1.1	Inputs and outputs	50
7.2	PROFIBUS PA.....	61
7.2.1	Overview of functional scope	61
7.2.2	Inputs and outputs	62
7.3	Power supply	64
7.4	Cable specification.....	64
8	Advanced functions and Features on Demand (FOD)	65
8.1	Concentration and petroleum measurement	66
8.2	Batching function	67
8.3	Viscosity function	68
8.4	Tube Health Check	69
8.5	Measurement of heat quantity	69
8.6	Features on Demand (FOD).....	70
9	Approvals and declarations of conformity	71
10	Ordering information.....	82
10.1	Overview model code Hygienic 25	82
10.2	Overview model code Hygienic 40	86
10.3	Overview model code Hygienic 50	90
10.4	Overview model code Hygienic 80	94
10.5	Overview options	98
10.6	Model code	102
10.6.1	Transmitter	102
10.6.2	Sensor.....	102
10.6.3	Meter size	103
10.6.4	Material wetted parts.....	103
10.6.5	Process connection size	103
10.6.6	Process connection type.....	103
10.6.7	Sensor housing material	104
10.6.8	Process fluid temperature range.....	104
10.6.9	Mass flow and density accuracy	104

- 10.6.10 Design and housing 105
- 10.6.11 Ex approval 106
- 10.6.12 Cable entries 106
- 10.6.13 Communication type and I/O 107
- 10.6.14 Display 109
- 10.7 Options 110
 - 10.7.1 Connecting cable type and length..... 111
 - 10.7.2 Additional nameplate information..... 111
 - 10.7.3 Presetting of customer parameters 111
 - 10.7.4 Concentration and petroleum measurement..... 112
 - 10.7.5 Batching function 112
 - 10.7.6 Viscosity function 112
 - 10.7.7 Enhanced process temperature (Explosion proof)..... 112
 - 10.7.8 Certificates 113
 - 10.7.9 Country-specific delivery 115
 - 10.7.10 Country-specific application 115
 - 10.7.11 Tube Health Check 115
 - 10.7.12 Transmitter housing rotated 180° 116
 - 10.7.13 Measurement of heat quantity 116
 - 10.7.14 Marine approval 116
 - 10.7.15 Sanitary options 117
 - 10.7.16 Cable glands and blind plug..... 117
 - 10.7.17 Customer-specific special product manufacture 117
- 10.8 Ordering Instructions 118

1 Introduction

1.1 Applicable documents

For Ex approval specification, refer to the following documents:

- Explosion Proof Type Manual ATEX IM 01U10X01-00__-R¹⁾
- Explosion Proof Type Manual IECEx IM 01U10X02-00__-R¹⁾
- Explosion Proof Type Manual FM IM 01U10X03-00__-R¹⁾
- Explosion Proof Type Manual INMETRO IM 01U10X04-00__-R¹⁾
- Explosion Proof Type Manual PESO IM 01U10X05-00__-R¹⁾
- Explosion Proof Type Manual NEPSI IM 01U10X06-00__-R¹⁾
- Explosion Proof Type Manual KOREA Ex IM 01U10X07-00__-R¹⁾
- Explosion Proof Type Manual EAC Ex IM 01U10X08-00__-R¹⁾
- Explosion Proof Type Manual Japan Ex IM 01U10X09-00__-R¹⁾

Other applicable User's manuals:

- Protection of Environment (Use in China only) IM 01A01B01-00ZH-R







¹⁾ The "_" symbols are placeholders. Here for example, for the corresponding language version (DE, EN, etc.).

1.2 Product overview

Rotamass Total Insight Coriolis mass flow and density meters are available in various product families distinguished by their applications. Each product family includes several product alternatives and additional device options that can be selected.

The following overview serves as a guide for selecting products.

Overview of Rotamass Total Insight product families

<p>Rotamass Nano</p>		<p>For low flow rate applications Meter sizes: Nano 06, Nano 08, Nano 10, Nano 15, Nano 20 Connection sizes: <ul style="list-style-type: none"> ▪ DN15, DN25, DN40 ▪ 1/4", 3/8", 1/2", 3/4", 1", 1 1/2" Maximum mass flow: 1.5 t/h (55 lb/min)</p>
<p>Rotamass Prime</p>		<p>Versatility with superior turndown and low pressure loss Meter sizes: Prime 25, Prime 40, Prime 50, Prime 80, Prime 1H Connection sizes: <ul style="list-style-type: none"> ▪ DN15, DN25, DN40, DN50, DN80, DN100, DN125 ▪ 3/8", 1/2", 3/4", 1", 1 1/2", 2", 2 1/2", 3", 4", 5" Maximum mass flow: 255 t/h (9400 lb/min)</p>
<p>Rotamass Supreme</p>		<p>Excellent performance under demanding conditions Meter sizes: Supreme 34, Supreme 36, Supreme 38, Supreme 39 Connection sizes: <ul style="list-style-type: none"> ▪ DN15, DN25, DN40, DN50, DN65, DN80, DN100, DN125 ▪ 3/8", 1/2", 3/4", 1", 1 1/2", 2", 2 1/2", 3", 4", 5" Maximum mass flow: 170 t/h (6200 lb/min)</p>
<p>Rotamass Intense</p>		<p>For high process pressure applications Meter sizes: Intense 34, Intense 36, Intense 38 Connection sizes: <ul style="list-style-type: none"> ▪ 3/8", 1/2", 3/4", 1", 2" Maximum mass flow: 50 t/h (1800 lb/min)</p>
<p>Rotamass Hygienic</p>		<p>For food, beverage and pharmaceutical applications Meter sizes: Hygienic 25, Hygienic 40, Hygienic 50, Hygienic 80 Connection sizes: <ul style="list-style-type: none"> ▪ DN25, DN40, DN50, DN65, DN80 ▪ 1", 1 1/2", 2", 2 1/2", 3" Maximum mass flow: 76 t/h (2800 lb/min)</p>
<p>Rotamass Giga</p>		<p>For high flow rate applications Meter sizes: Giga 1F, Giga 2H Connection sizes: <ul style="list-style-type: none"> ▪ DN100, DN125, DN150, DN200 ▪ 4", 5", 6", 8" Maximum mass flow: 600 t/h (22000 lb/min)</p>

2 Measuring principle and flow meter design

2.1 Measuring principle

The measuring principle is based on the generation of Coriolis forces. For this purpose, a driver system (E) excites the two measuring tubes (M1, M2) in their first resonance frequency. Both pipes vibrate inversely phased, similar to a resonating tuning fork.

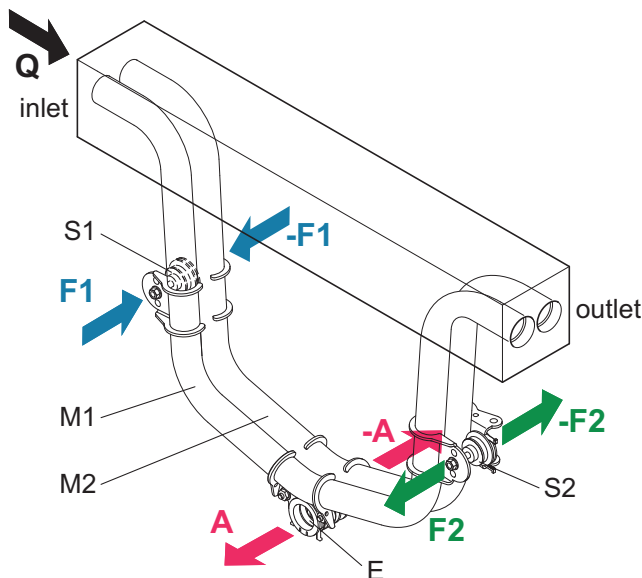

Fig. 1: Coriolis principle

M1, M2	Measuring tubes	E	Driver system
S1, S2	Pick-offs	A	Direction of measuring tube vibration
F1, F2	Coriolis forces	Q	Direction of fluid flow

Mass flow

The fluid flow through the vibrating measuring tubes generates Coriolis forces (F1, -F1 and F2, -F2) that produce positive or negative values for the tubes on the inflow or outflow side. These forces are directly proportional to the mass flow and result in deformation (torsion) of the measuring tubes.

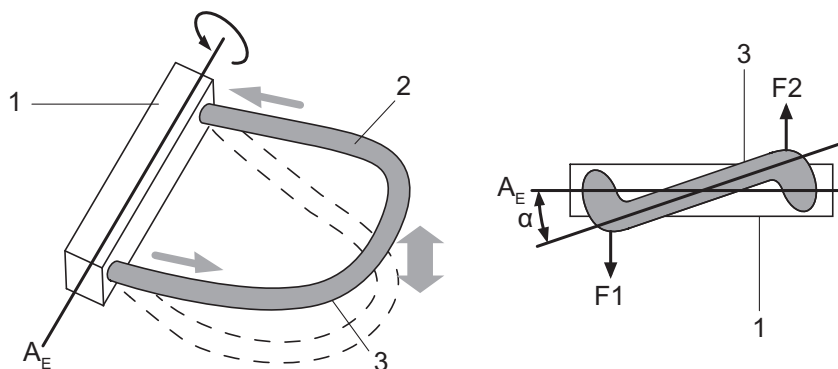

Fig. 2: Coriolis forces and measuring tube deformation

1	Measuring tube mount	A_E	Rotational axis
2	Fluid	F1, F2	Coriolis forces
3	Measuring tube	α	Torsion angle

The small deformation overlying the fundamental vibration is recorded by means of pick-offs (S1, S2) attached at suitable measuring tube locations. The resulting phase shift $\Delta\phi$ between the output signals of pick-offs S1 and S2 is proportional to the mass flow. The output signals generated are further processed in a transmitter.

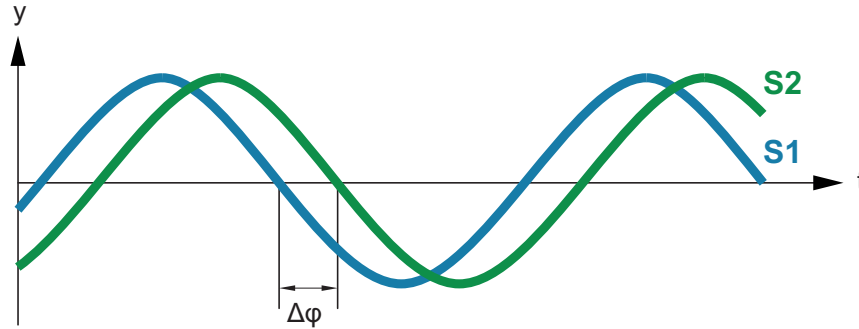

Fig. 3: Phase shift between output signals of S1 and S2 pick-offs

$$\Delta\phi \sim F_c \sim \frac{dm}{dt}$$

- $\Delta\phi$ Phase shift
- m Dynamic mass
- t Time
- dm/dt Mass flow
- F_c Coriolis force

Density measurement

Using a driver and an electronic regulator, the measuring tubes are operated in their resonance frequency f . This resonance frequency is a function of measuring tube geometry, material properties and the mass of the fluid covibrating in the measuring tubes. Altering the density and the attendant mass will alter the resonance frequency. The transmitter measures the resonance frequency and calculates density from it according to the formula below. Device-dependent constants are determined individually during calibration.

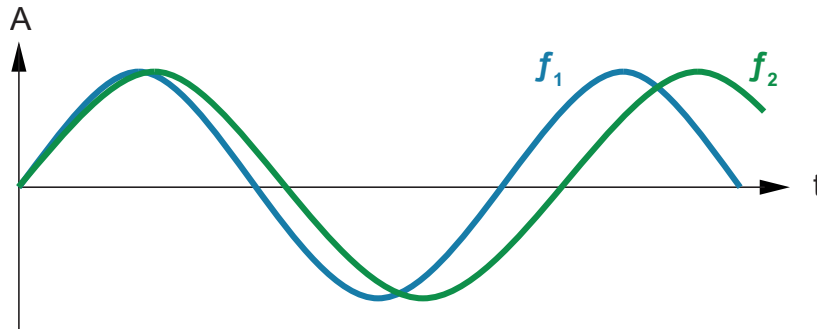

Fig. 4: Resonance frequency of measuring tubes

- A Measuring tube displacement
- f_1 Resonance frequency with fluid 1
- f_2 Resonance frequency with fluid 2

$$\rho = \frac{\alpha}{f^2} + \beta$$

- ρ Fluid density
- f Resonance frequency of measuring tubes
- α, β Device-dependent constants

Temperature measurement

The measuring tube temperature is measured in order to compensate the effects of temperature on the flow meter. This temperature approximately equals the fluid temperature and is made available as a measured quantity at the transmitter as well.

2.2 Flow meter

The Rotamass Coriolis flow meter consists of:

- Sensor
- Transmitter

When the integral type is used, sensor and transmitter are firmly connected.

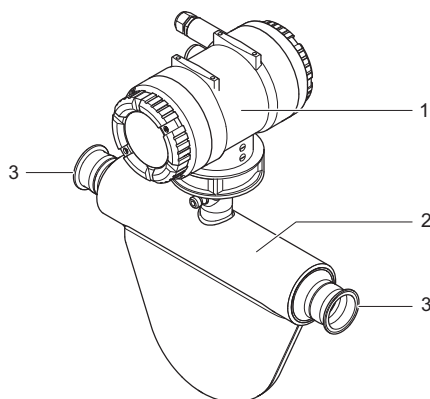

Fig. 5: Configuration of the Rotamass integral type

- | | |
|---|---------------------|
| 1 | Transmitter |
| 2 | Sensor |
| 3 | Process connections |

When the remote type is used, sensor and transmitter are linked via connecting cable. As a result, sensor and transmitter can be installed in different locations.

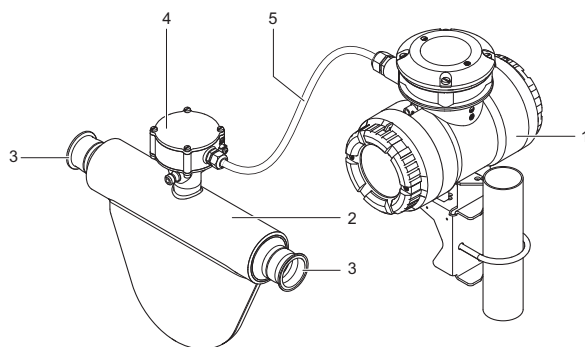

Fig. 6: Configuration of the Rotamass remote type

- | | | | |
|---|---------------------|---|---------------------|
| 1 | Transmitter | 4 | Sensor terminal box |
| 2 | Sensor | 5 | Connecting cable |
| 3 | Process connections | | |

General specifications

All available properties of the Rotamass Coriolis flow meter are specified by means of a model code.

One model code position may include several characters depicted by means of dashed lines.

The positions of the model code relevant for the respective properties are depicted and highlighted in blue. Any values that might occupy these model code positions are subsequently explained.

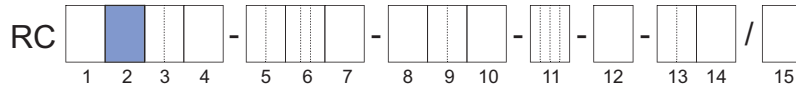

Fig. 7: Highlighted model code positions

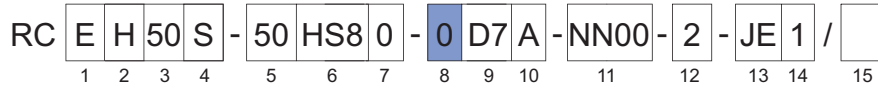
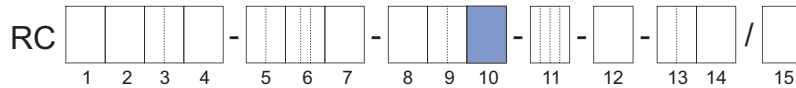

Fig. 8: Example of a completed model code

A complete description of the model code is included in the chapter *Ordering information* [▶ 82].

Type of design

Position 10 of the model code defines whether the integral type or the remote type is used. It specifies further flow meter properties, such as the transmitter coating, see *Design and housing* [▶ 105].



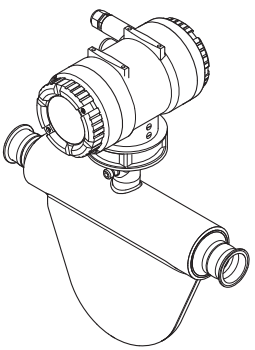
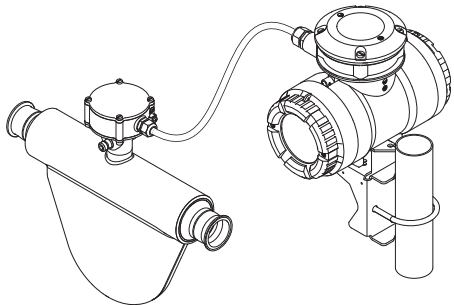

Flow meter	Model code position 10
<p>Integral type</p> 	0, 2
<p>Remote type</p> 	A, E, J

Transmitter overview Two different transmitters can be combined with the sensor: Essential and Ultimate.

Essential transmitter is suitable for general purposes applications and it delivers accurate and precise measurements of flow rate and density.

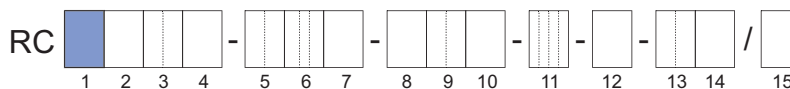
Ultimate transmitter, thanks to the advanced functions and "Features on Demand", offers dedicated application solutions with a superior accuracy and performances in measuring flow rate, density and concentration.



Transmitter	Properties	Model code position 1
<p>Essential</p> 	<ul style="list-style-type: none"> Down to 0.15 % mass flow accuracy for liquids Down to 0.75 % mass flow accuracy for gases Down to 4 g/l (0.25 lb/ft³) accuracy for density Total Health Check (diagnostic function) Advanced functions: <ul style="list-style-type: none"> Tube Health Check (diagnostic function) Communication: <ul style="list-style-type: none"> HART Modbus Data backup on microSD card 	E
<p>Ultimate</p> 	<ul style="list-style-type: none"> Down to 0.1 % mass flow accuracy for liquids Down to 0.5 % mass flow accuracy for gases Down to 0.5 g/l (0.03 lb/ft³) accuracy for density Total Health Check (diagnostic function) Advanced functions: <ul style="list-style-type: none"> Standard concentration measurement Advanced concentration measurement Viscosity function Batching function Measurement of heat quantity Tube Health Check (diagnostic function) Features on Demand Communication: <ul style="list-style-type: none"> HART Modbus PROFIBUS PA Data backup on microSD card 	U
No transmitter	<ul style="list-style-type: none"> Spare sensor without transmitter, combinable with Rotamass Total Insight transmitter 	N

3 Application and measuring ranges

3.1 Measured quantities

The Rotamass Coriolis flow meter can be used to measure the following fluids:

- Liquids
- Gases
- Mixtures, such as emulsions, suspensions, slurries

Possible limitations applying to measurement of mixtures must be checked with the responsible Yokogawa sales organization.

The following variables can be measured using Rotamass:

- Mass flow
- Density
- Temperature

Based on these measured quantities, the transmitter also calculates:

- Volume flow
- Partial component concentration of a two-component mixture
- Partial component flow rate of a mixture consisting of two components (net flow)

In this process, the net flow is calculated based on the known partial component concentration and the overall flow.

3.2 Measuring range overview

	Hygienic 25	Hygienic 40	Hygienic 50	Hygienic 80	
Mass flow range					
Typical connection size	DN25, 1"	DN40, 1½"	DN50, 2"	DN80, 3"	
Q _{nom}	1.6 t/h (59 lb/min)	4.7 t/h (170 lb/min)	20 t/h (730 lb/min)	51 t/h (1900 lb/min)	[13]
Q _{max}	2.3 t/h (85 lb/min)	7 t/h (260 lb/min)	29 t/h (1100 lb/min)	76 t/h (2800 lb/min)	
Maximum volume flow					
(Water)	2.3 m³/h (19 barrel/h)	7 m³/h (59 barrel/h)	29 m³/h (240 barrel/h)	76 m³/h (640 barrel/h)	[13]
Range of fluid density					
	0 – 5 kg/l (0 – 312 lb/ft³)				[14]
Process fluid temperature range					
Standard ¹⁾	-70 – 140 °C (-94 – 284 °F)				[28]

¹⁾ May be further restricted depending on the design and process connection type.

Q_{nom} - Nominal mass flow

Q_{max} - Maximum mass flow

The nominal mass flow Q_{nom} is defined as the mass flow of water (temperature: 20 °C) at 1 bar pressure loss along the flow meter.

3.3 Mass flow

For Rotamass Hygienic the following meter sizes to be determined using the *Model code* [► 102] are available.

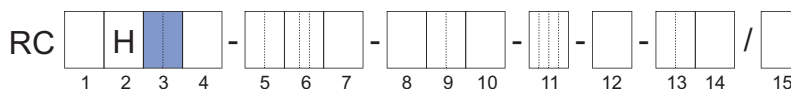

Mass flow of liquids

Meter size	Typical connection size	Q _{nom} in t/h (lb/min)	Q _{max} in t/h (lb/min)	Model code position 3
Hygienic 25	DN25, 1"	1.6 (59)	2.3 (85)	25
Hygienic 40	DN40, 1½"	4.7 (170)	7 (260)	40
Hygienic 50	DN50, 2"	20 (730)	29 (1100)	50
Hygienic 80	DN80, 3"	51 (1900)	76 (2800)	80

Mass flow of gases

When using Rotamass for measuring the flow of gases, the mass flow is usually limited by the pressure loss generated and the maximum flow velocity.

Type of gas	Maximum flow velocity
Oxygen	60 m/s
Methane	40 m/s
Natural gas	40 m/s
Other gases	33 % of sound velocity

3.4 Volume flow

Volume flow of liquids (water at 20 °C)

Meter size	Volume flow (at 1 bar pressure loss) in m ³ /h (barrel/h)	Maximum volume flow in m ³ /h (barrel/h)
Hygienic 25	1.6 (13)	2.3 (19)
Hygienic 40	4.7 (39)	7 (59)
Hygienic 50	20 (170)	29 (240)
Hygienic 80	51 (430)	76 (640)

Volume flow of gases

When using Rotamass for measuring the flow of gases, the flow rate is usually limited by the pressure loss generated and the maximum flow velocity.

Type of gas	Maximum flow velocity
Oxygen	60 m/s
Methane	40 m/s
Natural gas	40 m/s
Other gases	33 % of sound velocity

3.5 Pressure loss

The pressure loss along the flow meter is heavily dependent on the application. The pressure loss of 1 bar at nominal mass flow Q_{nom} also applies to water and is considered the reference value.

3.6 Density

Meter size	Measuring range of density
Hygienic 25	0 – 5 kg/l (0 – 312 lb/ft ³)
Hygienic 40	
Hygienic 50	
Hygienic 80	

Rather than being measured directly, density of gas is usually calculated using its reference density, process fluid temperature and process pressure.

3.7 Temperature

The process fluid temperature measuring range is limited by:

- Design type (integral or remote)
- Process connection size and type
- Ex approvals

Maximum measuring range: -70 – 140 °C (-94 – 284 °F)

4 Accuracy

In this chapter, maximum deviations are indicated as absolute values.



All accuracy data are given in \pm values.

4.1 Overview

Achievable accuracies for liquids

The value D_{flat} specified for accuracy of mass flow applies for flow rates exceeding the mass flow limit Q_{flat} . If the flow rate is less than Q_{flat} , other effects have to be considered.

If the flow rate is higher than Q_{nom} , other effects might influence the accuracy (e.g. cavitation).

The following values are achieved at calibration conditions when the device is delivered, see *Calibration conditions* [▶ 24]. Depending on the product version selected, specifications may not be as accurate, see *Mass flow and density accuracy* [▶ 104].

Measured quantity		Accuracy for transmitters	
		Essential	Ultimate
Mass flow ¹⁾	Accuracy ²⁾ D_{flat}	0.15 % of measured value	0.1 % of measured value
	Repeatability ³⁾	0.08 % of measured value	0.05 % of measured value
Volume flow (water) ¹⁾	Accuracy ²⁾ D_V	0.43 % of measured value	0.12 % of measured value
	Repeatability ³⁾	0.22 % of measured value	0.06 % of measured value
Density	Accuracy ²⁾	4 g/l (0.25 lb/ft ³)	0.5 g/l (0.03 lb/ft ³)
	Repeatability ³⁾	2 g/l (0.13 lb/ft ³)	0.3 g/l (0.02 lb/ft ³)
Temperature	Accuracy ²⁾	1.0 °C (1.8 °F)	1.0 °C (1.8 °F)

¹⁾ Based on the measured values of the pulse output. This means that the flow accuracy and repeatability considers the combined measurement uncertainties including sensor, electronic and pulse output interface.

²⁾ Best accuracy per transmitter type.

³⁾ The stated repeatability is included in the accuracy.

Achievable accuracies for gases

Measured quantity		Accuracy for transmitters	
		Essential	Ultimate
Mass flow / standard volume flow ¹⁾	Accuracy ²⁾ D_{flat}	0.75 % of measured value	0.5 % of measured value
	Repeatability ³⁾	0.6 % of measured value	0.4 % of measured value
Temperature	Accuracy ²⁾	1.0 °C (1.8 °F)	1.0 °C (1.8 °F)

¹⁾ Based on the measured values of the pulse output. This means that the flow accuracy and repeatability considers the combined measurement uncertainties including sensor, electronic and pulse output interface.

²⁾ Best mass flow accuracy per transmitter type.

³⁾ The stated repeatability is included in the accuracy.

4.2 Zero point stability of the mass flow

In case of no flow, the maximum measured flow rate is called *Zero point stability*. Zero point values are shown in the table below.

Meter size	Zero point stability Z in kg/h (lb/h)
Hygienic 25	0.032 (0.071)
Hygienic 40	0.094 (0.21)
Hygienic 50	0.4 (0.88)
Hygienic 80	2.55 (5.6)

4.3 Mass flow accuracy

Above mass flow Q_{flat} , maximum deviation is constant and referred to as D_{flat} . It depends on the product version and can be found in the tables in chapter *Accuracy of mass flow and density according to the model code* [▶ 21].

Use the following formulas to calculate the maximum deviation D :

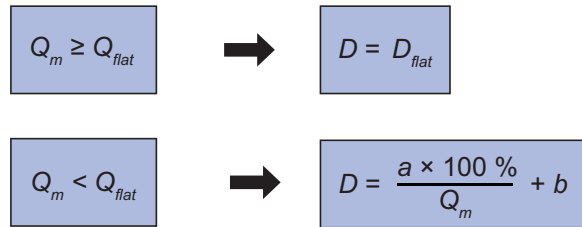

- $D^{1)}$ Maximum deviation in %
- D_{flat} Maximum deviation for high flow rates in %
- a, b Constants
- Q_m Mass flow in kg/h
- Q_{flat} Mass flow value above which D_{flat} applies, in kg/h

¹⁾ The repeatability is always 50 % of D and is included in the accuracy.

Meter size	Model code position 9	D_{flat} in %	Q_{flat} in kg/h	a in kg/h	b in %
Hygienic 25	E7	0.2	54	0.079	0.055
	D7	0.15	64	0.051	0.07
	C2, C3, C7	0.1	80	0.036	0.056
	70	0.75	54	0.079	0.605
	50	0.5	64	0.051	0.42
Hygienic 40	E7	0.2	155	0.24	0.046
	D7	0.15	188	0.15	0.07
	C2, C3, C7	0.1	235	0.1	0.056
	70	0.75	155	0.24	0.596
	50	0.5	188	0.15	0.42
Hygienic 50	E7	0.2	670	0.99	0.052
	D7	0.15	800	0.64	0.07
	C2, C3, C7	0.1	1000	0.44	0.056
	70	0.75	670	0.99	0.602
	50	0.5	800	0.64	0.42
Hygienic 80	E7	0.2	2040	4.1	0
	D7	0.15	2300	3.3	0.008
	C2, C3, C7	0.1	2550	2.8	-0.011
	70	0.75	2040	4.1	0.55
	50	0.5	2300	3.3	0.358

Accuracy using water at 20 °C as an example

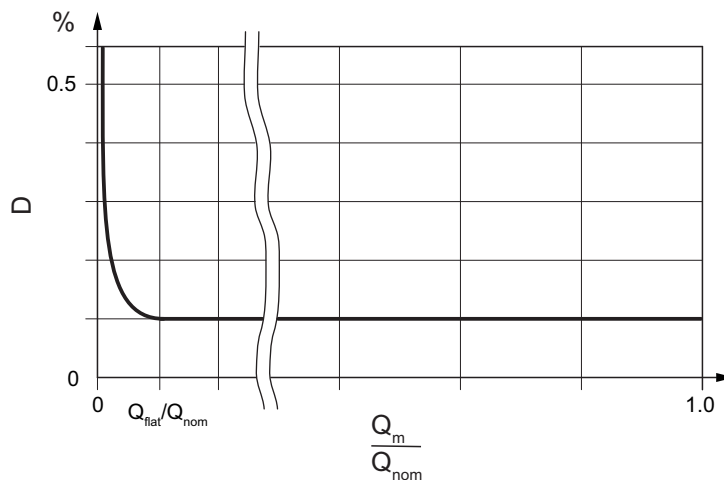

Fig. 9: Schematic dependency of the maximum deviation on the mass flow

- D Maximum deviation in %
- Q_{nom} Nominal mass flow in kg/h
- Q_m Mass flow in kg/h
- Q_{flat} Mass flow above which D_{flat} applies, in kg/h

4.3.1 Sample calculation for liquids

Turndown $Q_m : Q_{nom}$	Maximum deviation D	Water pressure loss
1:100	0.28 %	≈ 0 mbar (0 psi)
1:40	0.14 %	0.7 mbar (0.01 psi)
1:20	0.10 %	2.5 mbar (0.04 psi)
1:10	0.10 %	10 mbar (0.15 psi)
1:2	0.10 %	250 mbar (3.62 psi)
1:1	0.10 %	1000 mbar (14.50 psi)

Example

RC E H 50 S - 50 HS8 0 - 0 D7 A - NN00 - 2 - JE 1 /

1 2 3 4 5 6 7 8 9 10 11 12 13 14 15

Fluid: Liquid
 Maximum deviation D_{flat} : 0.15 %
 Q_{flat} : 800 kg/h
 Constant a : 0.64 kg/h
 Constant b : 0.07 %
 Value of mass flow Q_m : 500 kg/h

Calculation of flow rate condition:

Check whether $Q_m \geq Q_{flat}$:

$Q = 500 \text{ kg/h} < Q_{flat} = 800 \text{ kg/h}$

As a result, accuracy is calculated using the following formula:

$$D = \frac{a \times 100 \%}{Q_m} + b$$

Calculation of accuracy:

$D = 0.64 \text{ kg/h} \times 100 \% / 500 \text{ kg/h} + 0.07 \%$

$D = 0.20 \%$

4.3.2 Sample calculation for gases

The maximum deviation in the case of gases depends on the product version selected, see also *Mass flow and density accuracy* [► 104].

Example

RC

E	H	50	S
---	---	----	---

 -

50	HS8	0
----	-----	---

 -

0	70	A
---	----	---

 -

NN00

 -

2

 -

JE	1
----	---

 /

--

1
2
3
4
5
6
7
8
9
10
11
12
13
14
15

Fluid:	Gas
Maximum deviation D_{flat} :	0.75 %
Q_{flat} :	670 kg/h
Constant a :	0.99 kg/h
Constant b :	0.602 %
Value of mass flow Q_m :	200 kg/h

Calculation of the flow rate condition:

Check whether $Q_m \geq Q_{\text{flat}}$:

$$Q_m = 200 \text{ kg/h} < Q_{\text{flat}} = 670 \text{ kg/h}$$

As a result, the accuracy is calculated using the following formula:

$$D = \frac{a \times 100 \%}{Q_m} + b$$

Calculation of accuracy:

$$D = 0.99 \text{ kg/h} \times 100 \% / 200 \text{ kg/h} + 0.602 \%$$

$$D = 1.10 \%$$

4.4 Accuracy of density

4.4.1 For liquids

Meter size	Transmitter	Maximum deviation of density ¹⁾ in g/l (lb/ft ³)
Hygienic 25	Essential	Down to 4 (0.25)
Hygienic 40		
Hygienic 50		
Hygienic 80		
Hygienic 25	Ultimate	Down to 0.5 (0.03)
Hygienic 40		
Hygienic 50		
Hygienic 80		

¹⁾ Deviations possible depending on product version (type of calibration)

The maximum deviation depends on the product version selected, see also *Accuracy of mass flow and density according to the model code* [▶ 21].

4.4.2 For gases

In most applications, density at standard conditions is fed into the transmitter and used to calculate the standard volume flow based on mass flow.

If gas pressure is a known value, after entering a reference density, the transmitter is able to calculate gas density from temperature and pressure as well (while assuming an ideal gas).

Alternatively, there is an option for measuring gas density. In order to do so, it is necessary to adapt the lower density limit value in the transmitter.

For most applications the direct measurement of the gas density will have insufficient accuracy.

4.5 Accuracy of mass flow and density according to the model code

Accuracy for flow rate as well as density is selected via model code position 9. Here a distinction is made between devices for measuring liquids and devices for measuring gases. No accuracy for density measurement is specified for gas measurement devices.

4.5.1 For liquids

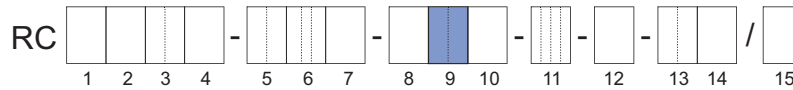

Essential

Model code position 9	Maximum deviation of density ¹⁾ in g/l	Applicable measuring range of accuracy in kg/l	Maximum deviation D_{flat} for mass flow in %			
			Hygienic 25	Hygienic 40	Hygienic 50	Hygienic 80
E7	4	0.3 – 3.6	0.2	0.2	0.2	0.2
D7	4	0.3 – 3.6	0.15	0.15	0.15	0.15

¹⁾ Specified maximum deviation is achieved within the applicable measuring range for density.

Ultimate

Model code position 9	Maximum deviation of density ¹⁾ in g/l	Applicable measuring range of accuracy in kg/l	Maximum deviation D_{flat} for mass flow in %			
			Hygienic 25	Hygienic 40	Hygienic 50	Hygienic 80
E7	4	0.3 – 3.6	0.2	0.2	0.2	0.2
D7	4	0.3 – 3.6	0.15	0.15	0.15	0.15
C7 ²⁾	4	0.3 – 3.6	0.1	0.1	0.1	0.1
C3	1	0.3 – 2.4	0.1	0.1	0.1	0.1
C2 ²⁾	0.5	0.3 – 2.4	0.1	0.1	0.1	0.1

¹⁾ Specified maximum deviation is achieved within the applicable measuring range for density.

²⁾ Notice: In case of a spare sensor combined with a transmitter in use, the original accuracy specification may be affected. For calibration services, please contact Yokogawa Service department.

4.5.2 For gases

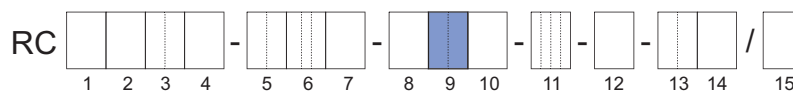

Essential

Model code position 9	Maximum deviation D_{flat} of mass flow in %
70	0.75

Ultimate

Model code position 9	Maximum deviation D_{flat} of mass flow in %
50 ¹⁾	0.5

¹⁾ Notice: In case of a spare sensor combined with a transmitter in use, the original accuracy specification may be affected. For calibration services, please contact Yokogawa Service department.

4.6 Volume flow accuracy

4.6.1 For liquids

The following formula can be used to calculate the accuracy of liquid volume flow:

$$D_V = \sqrt{D^2 + \left(\frac{\Delta\rho}{\rho} \times 100\%\right)^2}$$

D_V Maximum deviation of volume flow in %

$\Delta\rho$ Maximum deviation of density in kg/l

D Maximum deviation of mass flow in %

ρ Density in kg/l

4.6.2 For gases

Accuracy of standard volume flow for gas with a fixed composition equals the maximum deviation D of the mass flow.

$$D_V = D$$



In order to determine the standard volume flow for gas, it is necessary to input a reference density in the transmitter. The accuracy specified is achieved only for fixed gas composites. Major deviations may appear if the gas composition changes.

4.7 Accuracy of temperature

Various process fluid temperature ranges are specified for Rotamass Hygienic:

- Integral type: -50 – 140 °C (-58 – 284 °F)
- Remote type: -70 – 140 °C (-94 – 284 °F)

Accuracy of temperature depends on the sensor temperature range selected (see *Process fluid temperature range* [▶ 28]) and can be calculated as follows:

Formula for temperature specification Standard

$$\Delta T = 1.0 \text{ °C} + 0.0075 \times |T_{pro} - 20 \text{ °C}|$$

ΔT Maximum deviation of temperature

T_{pro} Process fluid temperature in °C

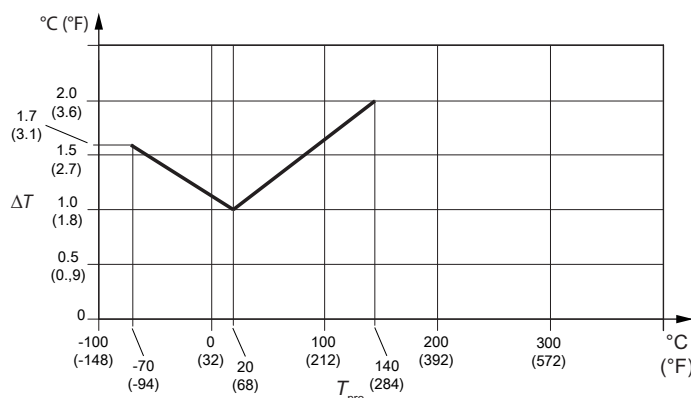

Fig. 10: Presentation of temperature accuracy

Example

RC E H 50 S - 50 HS8 0 - 0 D7 A - NN00 - 2 - JE 1 /

1 2 3 4 5 6 7 8 9 10 11 12 13 14 15

The sample model code specifies the Standard temperature range.

Process fluid temperature T_{pro} : 50 °C

Calculation of accuracy:

$$\Delta T = 1.0 \text{ °C} + 0.0075 \times |50 \text{ °C} - 20 \text{ °C}|$$

$$\Delta T = 1.225 \text{ °C}$$

4.8 Repeatability

For liquids

When using default damping times, the specified repeatability of mass flow, density and temperature measurements equals half of the respective maximum deviation.

$$R = \frac{D}{2}$$

R Repeatability

D Maximum deviation

For gases

In deviation hereto, the following applies to mass and standard volume flow of gases:

$$R = \frac{D}{1.25}$$

4.9 Calibration conditions

4.9.1 Mass flow calibration and density adjustment

All Rotamass are calibrated in accordance with the state of the art at Rota Yokogawa. Optionally, the calibration can be performed according to a method accredited by DAkkS in accordance with DIN EN ISO/IEC 17025 (Option K5, see *Certificates* [▶ 113]).

Each Rotamass device comes with a standard calibration certificate.

Calibration takes place at reference conditions. Specific values are listed in the standard calibration certificate.

	Reference conditions
Fluid	Water
Density	0.9 – 1.1 kg/l (56 – 69 lb/ft ³)
Fluid temperature	10 – 35 °C (50 – 95 °F) Average temperature: 22.5 °C (72.5 °F)
Ambient temperature	10 – 35 °C (50 – 95 °F)
Process pressure (absolute)	1 – 2 bar (15 – 29 psi)

The accuracy specified is achieved at as-delivered calibration conditions stated.

4.9.2 Density calibration

Density calibration is performed for maximum deviation of 0.5 g/l (0.03 lb/ft³), (model code pos. 9 _2).

Density calibration includes:

- Determination of calibration constants for fluid densities at 0.7 kg/l (44 lb/ft³), 1 kg/l (62 lb/ft³) and 1.65 kg/l (103 lb/ft³) at 20 °C (68 °F) fluid temperature
- Determination of temperature compensation coefficients at 20 – 80 °C (68 – 176 °F)
- Check of results for fluid densities at 0.7 kg/l (44 lb/ft³), 1 kg/l (62 lb/ft³) and 1.65 kg/l (103 lb/ft³) at 20 °C (68 °F) fluid temperature
- Creation of density calibration certificate

4.10 Process pressure effect

Process pressure effect is defined as the change in sensor flow and density deviation due to process pressure change away from the calibration pressure. This effect can be corrected by dynamic pressure input or a fixed process pressure.

Tab. 1: Process pressure effect

Meter size	Deviation of Flow		Deviation of Density	
	in % of rate per bar	in % of rate per psi	in g/l per bar	in g/l per psi
Hygienic 25	-0.0020	-0.00014	-0.021	-0.0015
Hygienic 40	-0.0084	-0.00058	-0.151	-0.0104
Hygienic 50	-0.0109	-0.00075	-0.073	-0.0050
Hygienic 80	-0.0130	-0.0009	-0.091	-0.0063

4.11 Process fluid temperature effect

For mass flow and density measurement, process fluid temperature effect is defined as the change in sensor flow and density accuracy due to process fluid temperature change away from the calibration temperature. For temperature ranges, see *Process fluid temperature range* [▶ 28].

Temperature effect on Zero

Temperature effect on Zero of mass flow can be corrected by zeroing at the process fluid temperature.

Temperature effect on mass flow

The process fluid temperature is measured and the temperature effect compensated. However due to uncertainties in the compensation coefficients and in the temperature measurement an uncertainty of this compensation is left. The typical rest error of Rotamass Total Insight temperature effect on mass flow is:

Tab. 2: All models

Temperature range	Uncertainty of flow
Standard	±0.0009 % of rate / °C (±0.0005 % of rate / °F)

The temperature used for calculation of the uncertainty is the difference between process fluid temperature and the temperature at calibration condition. For temperature ranges, see *fluid temperature range* [▶ 28].

Temperature effect on density measurement (liquids)

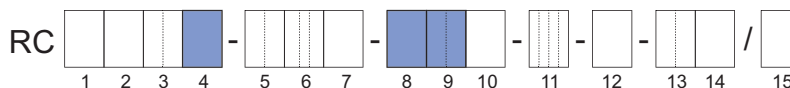

Process fluid temperature influence:

Formula for metric values

$$D'_\rho = \pm k \times \text{abs}(T_{\text{pro}} - 20 \text{ }^\circ\text{C})$$

Formula for imperial values

$$D'_\rho = \pm k \times \text{abs}(T_{\text{pro}} - 68 \text{ }^\circ\text{F})$$

D'_ρ Additional density deviation due to the effect of fluid temperature in g/l (lb/ft³)

T_{pro} Process fluid temperature in °C (°F)

k Constant for temperature effect on density measurement in g/l × 1/°C (lb/ft³ × 1/°F)

Tab. 3: Constants for particular meter size and model code position (see also *Process fluid temperature range* [▶ 28] and *Mass flow and density accuracy* [▶ 104])

Meter size	Model code position 4	Model code position 8	Model code position 9	k in g/l × 1/°C (lb/ft ³ × 1/°F)
Hygienic 25	S	0	C3, C7, D7, E7	0.210 (0.0073)
			C2	0.041 (0.0014)
Hygienic 40			C3, C7, D7, E7	0.140 (0.0049)
			C2	0.027 (0.0009)
Hygienic 50			C3, C7, D7, E7	0.120 (0.0042)
			C2	0.025 (0.0009)
Hygienic 80			C3, C7, D7, E7	0.130 (0.0045)
			C2	0.025 (0.0009)

5 Operating conditions

5.1 Location and position of installation

Rotamass Coriolis flow meters can be mounted horizontally, vertically and at an incline. The measuring tubes should be completely filled with the fluid during flow measurement as accumulations of air or formation of gas bubbles in the measuring tube may result in errors in measurement. Straight pipe runs at inlet or outlet are usually not required.

Avoid the following installation locations and positions:

- Measuring tubes as highest point in piping when measuring liquids
- Measuring tubes as lowest point in piping when measuring gases
- Immediately in front of a free pipe outlet in a downpipe
- Lateral positions

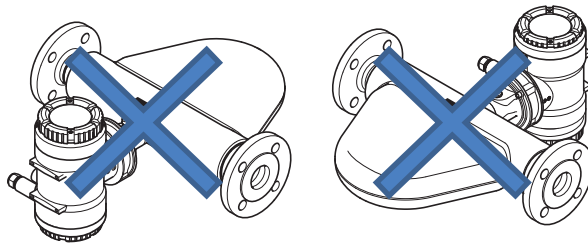
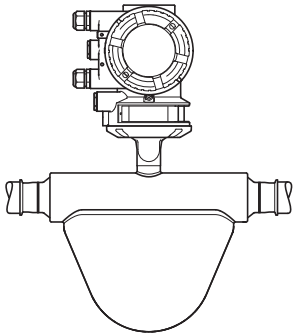
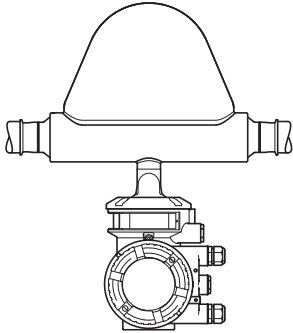
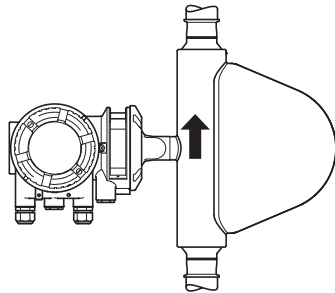

Fig. 11: Installation position to be avoided: Flow meter in sideways position

5.1.1 Sensor installation position

Sensor installation position as a function of the fluid

Installation position	Fluid	Description
Horizontal, measuring tubes at bottom 	Liquid	The measuring tubes are oriented toward the bottom. Accumulation of gas bubbles is avoided.
Horizontal, measuring tubes at top 	Gas	The measuring tubes are oriented toward the top. Accumulation of liquid, such as condensate is avoided.

Installation position	Fluid	Description
Vertical, direction of flow towards the top (recommended) 	Liquid/gas	The sensor is installed on a pipe with the direction of flow towards the top. Accumulation of gas bubbles or solids is avoided. This position allows for complete self-draining of the measuring tubes.

5.2 Installation instructions

The following instructions for installation must be observed:

1. Protect the flow meter from direct solar irradiation in order to avoid exceeding the maximum allowed temperature of the transmitter.
2. In case of installing two sensors of the same kind back-to-back redundantly, use a customized design and contact the responsible Yokogawa sales organization.
3. Avoid installation locations susceptible to cavitation, such as immediately behind a control valve.
4. Avoid installation directly behind rotary and gear pumps to prevent fluctuations in pressure from interfering with the resonance frequency of the Rotamass measuring tubes.
5. In case of remote installation: When installing the connecting cable between sensor and transmitter, keep the cable temperature above $-10\text{ }^{\circ}\text{C}$ ($14\text{ }^{\circ}\text{F}$) to prevent cable damage from the installation stresses.

5.3 Process conditions



The pressure and temperature ratings presented in this section represent the design values for the devices. For individual applications (e.g. marine applications with option MC_) further limitations may apply according to the respective applicable regulations. For details see chapter *Marine approval* [▶ 116].

5.3.1 Process fluid temperature range



Allowed process fluid and ambient temperature ranges in hazardous areas depend on classifications defined by applications, refer to *Temperature specification in hazardous areas* [▶ 35].

For Rotamass Hygienic the following process fluid temperature ranges are available:

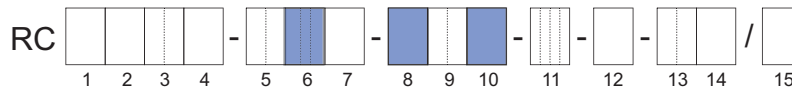

Temperature range	Model code position 6	Model code position 8	Process fluid temperature in °C (°F)	Design type	Model code position 10
Standard	HS2, HS9	0	-50 – 140 (-58 – 284)	Integral type	0, 2
			-70 – 140 (-94 – 284)	Remote type	A, E, J
	HS4		-10 – 140 (14 – 284)	Integral type	0, 2
			-10 – 140 (14 – 284)	Remote type	A, E, J
	HS8		-10 – 140 (14 – 284)	Integral type	0, 2
			-10 – 140 (14 – 284)	Remote type	A, E, J

5.3.2 Density

Meter size	Measuring range of density
Hygienic 25	0 – 5 kg/l (0 – 312 lb/ft³)
Hygienic 40	
Hygienic 50	
Hygienic 80	

Rather than being measured directly, density of gas is usually calculated using its reference density, process fluid temperature and process pressure.

5.3.3 Pressure

The maximum allowed process pressure depends on the selected process connection and its surface temperature.

The given process connection temperature and process pressure ranges are calculated and approved without corrosion or erosion effects.

The following diagrams shows the process pressure as a function of process connection temperature as well as the process connection used (type and size of process connection).

Threaded connection according to DIN 11851

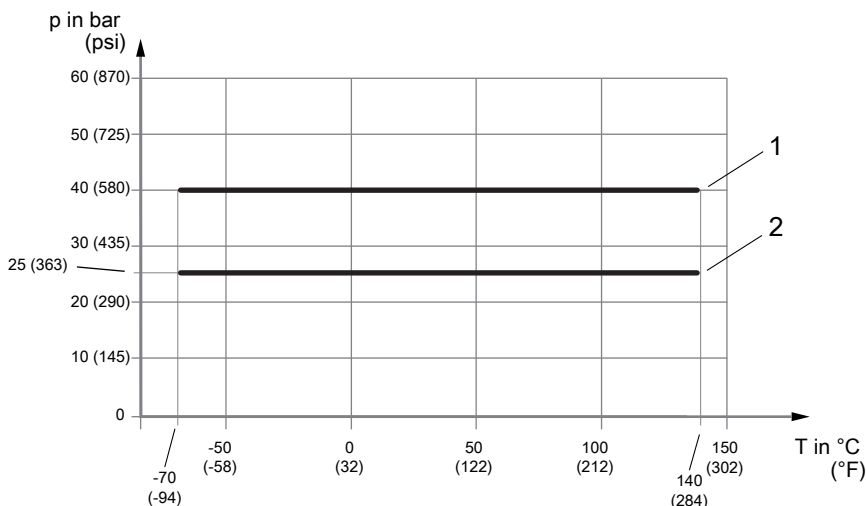

Fig. 12: Allowed process pressure as a function of process connection temperature

- 1 Threaded connection suitable for DIN 11851 up to DN40
- 2 Threaded connection suitable for DIN 11851 from DN50 to DN100

Clamp process connection according to DIN 32676 series A

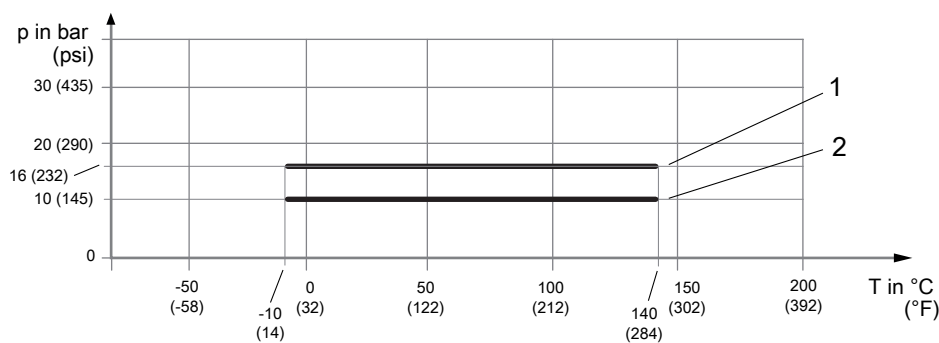

Fig. 13: Allowed process pressure as a function of process connection temperature

- 1 Clamp connection suitable for DIN 32676 series A up to DN50
- 2 Clamp connection suitable for DIN 32676 series A above DN50

Clamp process connection according to DIN 32676 series C (Tri-Clamp)

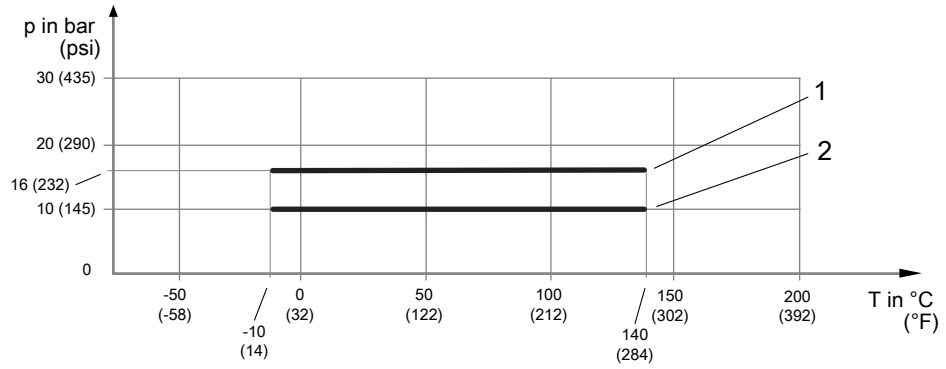

Fig. 14: Allowed process pressure as a function of process connection temperature

- 1 Clamp connection suitable for DIN 32676 series C up to 2"
- 2 Clamp connection suitable for DIN 32676 series C above 2"

Clamp process connection according to JIS/ISO 2852

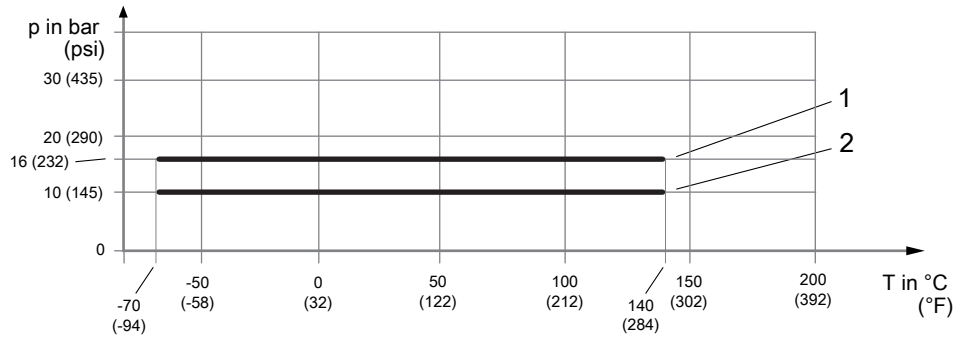

Fig. 15: Allowed process pressure as a function of process connection temperature

- 1 Clamp process connection suitable for JIS/ISO 2852 up to 2"
- 2 Clamp process connection suitable for JIS/ISO 2852 above 2"

5.4 Ambient conditions

Rotamass Total Insight can be used at demanding ambient conditions.

In doing so, the following specifications must be taken into account:

The air surrounding the device is considered as ambient temperature.

Allowed ambient and storage temperature of Rotamass Total Insight depends on the below components and their own temperature limits:

- Sensor
- Transmitter
- Connecting cable between sensor and transmitter (for remote design type)

Ambient temperature

If the device is operating outdoors make sure that the solar irradiation does not increase the surface temperature of the device higher than the allowed maximum ambient temperature. Transmitter display has limited legibility below -20 °C (-4 °F).

Maximum ambient temperature range		
integral type:		-40 – 60 °C (-40 – 140 °F)
remote type		
with standard cable (option L ₀₀₀):	Sensor ¹⁾ :	-50 – 80 °C (-58 – 176 °F)
	Transmitter:	-40 – 60 °C (-40 – 140 °F)
with fire retardant cable ²⁾ (option Y ₀₀₀):	Sensor ¹⁾ :	-35 – 80 °C (-31 – 176 °F)
	Transmitter:	-35 – 60 °C (-31 – 140 °F)

¹⁾ Check derating for high fluid temperature, see *Process fluid temperature range* [▶ 28], *Process conditions* [▶ 28] and *Allowed ambient temperature for sensor* [▶ 33]

²⁾ Lower temperature specification valid for fixed installation only

Storage temperature

Maximum storage temperature range		
integral type		-40 – 60 °C (-40 – 140 °F)
remote type		
with standard cable (option L ₀₀₀):	Sensor:	-50 – 80 °C (-58 – 176 °F)
	Transmitter:	-40 – 60 °C (-40 – 140 °F)
with fire retardant cable (option Y ₀₀₀):	Sensor:	-35 – 80 °C (-31 – 176 °F)
	Transmitter:	-35 – 60 °C (-31 – 140 °F)

Further ambient conditions

Ranges and specifications	
Relative humidity	0 – 95 %
IP code	IP66/67 for transmitters and sensors when using the appropriate cable glands
Allowable pollution degree in surrounding area acc. EN 61010-1	4 (in operation)
Vibration resistance acc. IEC 60068-2-6	Transmitter: 10 – 500 Hz, 1g Sensor: 10 – 500 Hz, 1g

Ranges and specifications	
<p>Electromagnetic compatibility (EMC)</p> <ul style="list-style-type: none"> ▪ IEC/EN 61326-1, Table 2 ▪ IEC/EN 61326-2-3 ▪ NAMUR NE 21 recommendation ▪ DNVGL-CG-0339, chapter 14 <p>This includes</p> <ul style="list-style-type: none"> ▪ Surge immunity acc.: <ul style="list-style-type: none"> – EN 61000-4-5 for lightning protection ▪ Emission acc.: <ul style="list-style-type: none"> – IEC/EN 61000-3-2, Class A – IEC/EN 61000-3-3, Class A – NAMUR NE 21 recommendation – DNVGL-CG-0339, chapter 14 	<p>Immunity assessment criterion: The output signal fluctuation is within $\pm 1\%$ of the output span.</p>
Maximum altitude	2000 m (6600 ft) above mean sea level (MSL)
Overvoltage category acc. IEC/EN 61010-1	II

5.4.1 Allowed ambient temperature for sensor

The allowed ambient temperature of the sensor depends on the following product properties:

- Process fluid temperature, see *Process fluid temperature range* [▶ 28]
- Design type
 - Integral type
 - Remote type
- Connecting cable type (options L_ and Y_)

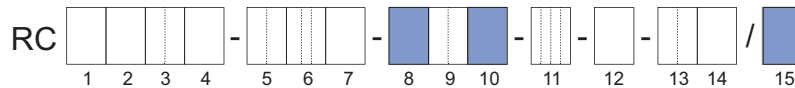

The allowed combinations of process fluid and ambient temperature for the sensor are illustrated as gray areas in the diagrams below.



Allowed process fluid and ambient temperature ranges in hazardous areas depend on classifications defined by applications, refer to *Temperature specification in hazardous areas* [▶ 35].

Temperature specification Standard, integral type

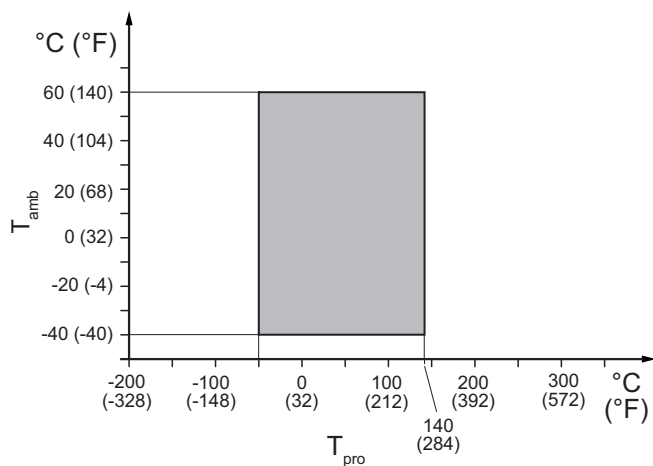

Fig. 16: Allowed process fluid and ambient temperatures, integral type for process connection type HS2 and HS9

T_{amb} Ambient temperature
 T_{pro} Process fluid temperature

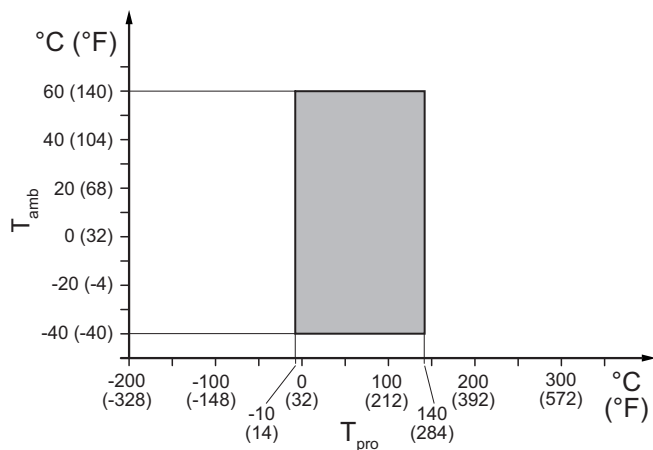

Fig. 17: Allowed process fluid and ambient temperatures, integral type for process connection type HS4 and HS8

Temperature specification Standard, remote type

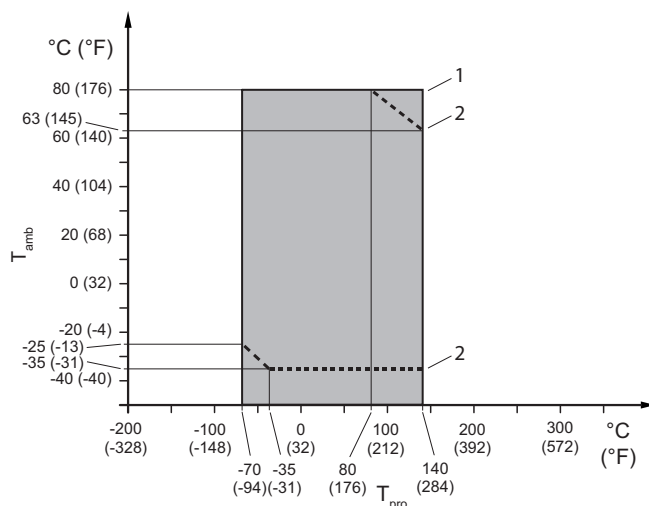

Fig. 18: Allowed process fluid and ambient temperatures, remote type for process connection type HS2 and HS9

- 1 Standard cable option L_ _ _ _
- 2 Limitation for fire retardant cable option Y_ _ _ _

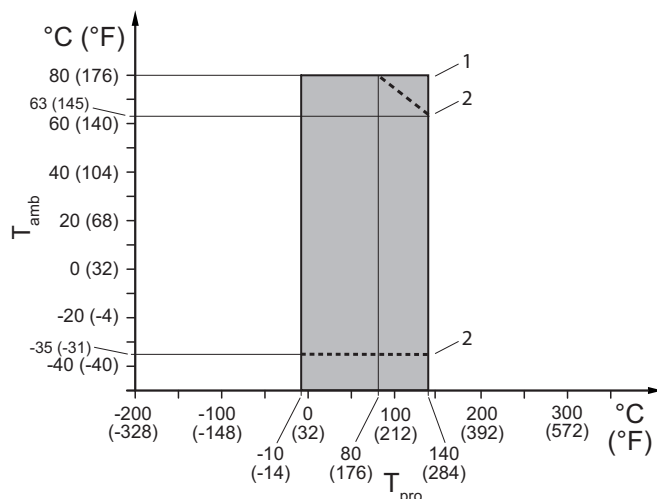

Fig. 19: Allowed process fluid and ambient temperatures, remote type for process connection type HS4 and HS8

- 1 Standard cable option L_ _ _ _
- 2 Limitation for fire retardant cable option Y_ _ _ _

5.4.2 Temperature specification in hazardous areas

The maximum ambient and process fluid temperature of Integral type and Remote Sensor depending on explosion groups and temperature classes are related to different characteristics:

- Size of the sensor (model code Pos.3)
- Design and housing (model code Pos.10)
- Type of EX approval (model code Pos.11)
- Enhanced process fluid temperature (model code Pos.15: option “EPT”)



Note: The maximum process fluid temperature could be further restricted due to process connection type see *Allowed ambient temperature for sensor* [▶ 33].

Model code:

Pos. 2: H

Pos. 3: 25, 40

Pos. 10: 0, 2

Pos. 11: _F21, _F22, FF11, FF12

Pos. 15: –

Ex code:

7.66.66.68.54.10

The following figure shows the relevant positions of the model code:

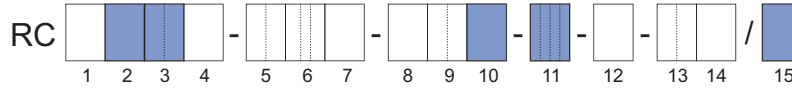

Tab. 4: Temperature classification

Temperature class	Maximum ambient temperature in °C (°F)	Maximum fluid temperature in °C (°F)
T6	43 (109)	47 (116)
T5	58 (136)	62 (143)
T4	60 (140)	99 (210)
T3	60 (140)	150 (302)
T2	60 (140)	150 (302)
T1	60 (140)	150 (302)

Model code:

Pos. 2: H

Pos. 3: 25, 40

Pos. 10: 0, 2

Pos. 11: _F21, _F22, FF11, FF12

Pos. 15: EPT

Ex code:

1.83.83.84.54.10

The following figure shows the relevant positions of the model code:

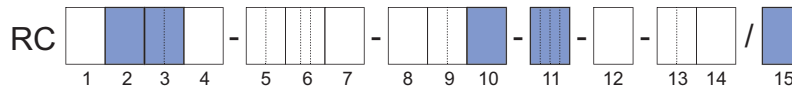

Tab. 5: Temperature classification

Temperature class	Maximum ambient temperature in °C (°F)	Maximum fluid temperature in °C (°F)
T6	60 (140)	64 (147)
T5	60 (140)	79 (174)
T4	60 (140)	115 (239)
T3	60 (140)	150 (302)
T2	60 (140)	150 (302)
T1	60 (140)	150 (302)

Model code:

Pos. 2: H

Pos. 3: 50

Pos. 10: 0, 2

Pos. 11: _F21, _F22, FF11, FF12

Pos. 15: –

Ex code:

2.73.72.76.54.10

The following figure shows the relevant positions of the model code:

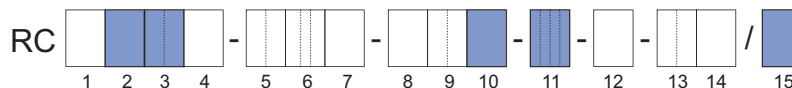

Tab. 6: Temperature classification

Temperature class	Maximum ambient temperature in °C (°F)	Maximum fluid temperature in °C (°F)
T6	54 (129)	54 (129)
T5	60 (140)	68 (154)
T4	60 (140)	107 (224)
T3	60 (140)	150 (302)
T2	60 (140)	150 (302)
T1	60 (140)	150 (302)

Model code:

Pos. 2: H

Pos. 3: 50

Pos. 10: 0, 2

Pos. 11: _F21, _F22, FF11, FF12

Pos. 15: EPT

Ex code:

1.91.91.91.54.10

The following figure shows the relevant positions of the model code:

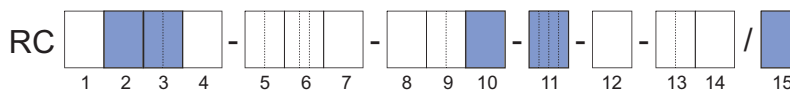

Tab. 7: Temperature classification

Temperature class	Maximum ambient temperature in °C (°F)	Maximum fluid temperature in °C (°F)
T6	60 (140)	72 (161)
T5	60 (140)	87 (188)
T4	60 (140)	122 (251)
T3	60 (140)	150 (302)
T2	60 (140)	150 (302)
T1	60 (140)	150 (302)

Model code:

Pos. 2: H

Pos. 3: 80

Pos. 10: 0, 2

Pos. 11: _F21, FF11

Pos. 15: –

Ex code:

7.83.84.86.54.10

The following figure shows the relevant positions of the model code:

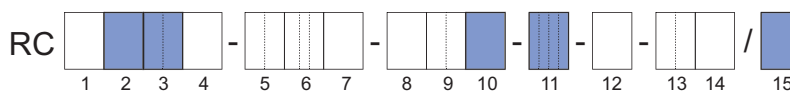

Tab. 8: Temperature classification

Temperature class	Maximum ambient temperature in °C (°F)	Maximum fluid temperature in °C (°F)
T6	40 (104)	64 (147)
T5	55 (131)	80 (176)
T4	60 (140)	117 (242)
T3	60 (140)	150 (302)
T2	60 (140)	150 (302)
T1	60 (140)	150 (302)

Model code:

Pos. 2: H

Pos. 3: 80

Pos. 10: 0, 2

Pos. 11: _F22, FF12

Pos. 15: –

Ex code:

6.83.84.86.54.10

The following figure shows the relevant positions of the model code:

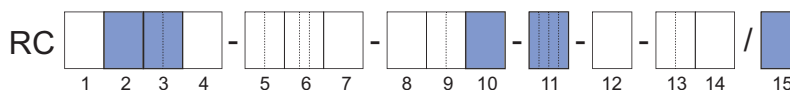

Tab. 9: Temperature classification

Temperature class	Maximum ambient temperature in °C (°F)	Maximum fluid temperature in °C (°F)
T6	44 (111)	64 (147)
T5	59 (138)	80 (176)
T4	60 (140)	117 (242)
T3	60 (140)	150 (302)
T2	60 (140)	150 (302)
T1	60 (140)	150 (302)

Model code:

Pos. 2: H

Pos. 3: 25, 40

Pos. 10: 0, 2

Pos. 11: JF54, JF53

Ex code:

-

The following figure shows the relevant positions of the model code:

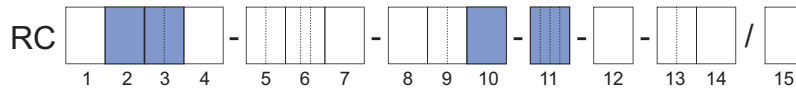

Tab. 10: Temperature classification

Temperature class	Maximum ambient temperature in °C	Maximum fluid temperature in °C
T4	60	99
T3	60	150

Model code:

Pos. 2: H

Pos. 3: 50

Pos. 10: 0, 2

Pos. 11: JF54, JF53

Ex code:

-

The following figure shows the relevant positions of the model code:

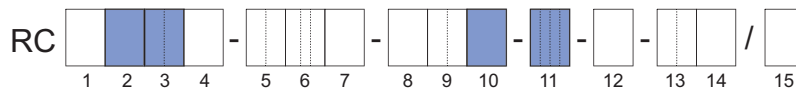

Tab. 11: Temperature classification

Temperature class	Maximum ambient temperature in °C	Maximum fluid temperature in °C
T4	60	107
T3	60	150

Model code:

Pos. 2: H

Pos. 3: 80

Pos. 10: 0, 2

Pos. 11: JF54, JF53

Ex code:

-

The following figure shows the relevant positions of the model code:

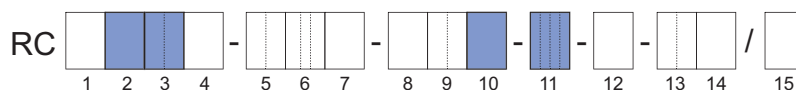

Tab. 12: Temperature classification

Temperature class	Maximum ambient temperature in °C	Maximum fluid temperature in °C
T4	60	117
T3	60	150

Model code:

Pos. 2: H

Pos. 3: 25, 40

Pos. 10: A, E, J

Pos. 11: _F21, _F22, FF11, FF12

Pos. 15: -

Ex code:

7.66.66.68.66.60

The following figure shows the relevant positions of the model code:

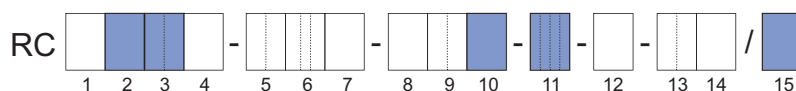

Tab. 13: Temperature classification

Temperature class	Maximum ambient temperature in °C (°F)		Maximum fluid temperature in °C (°F)
	Option L_	Option Y_	
T6	46 (114)	46 (114)	47 (116)
T5	61 (141)	61 (141)	62 (143)
T4	80 (176)	74 (165)	99 (210)
T3	74 (165)	56 (132)	162 (323)
T2	60 (140)	46 (114)	200 (392)
T1	60 (140)	46 (114)	200 (392)

Option Y_ not with model code pos. 11: FF11, FF12

Model code:

Pos. 2: H

Pos. 3: 25, 40

Pos. 10: A, E, J

Pos. 11: _F21, _F22, FF11, FF12

Pos. 15: EPT

Ex code:

1.83.83.84.82.60

The following figure shows the relevant positions of the model code:

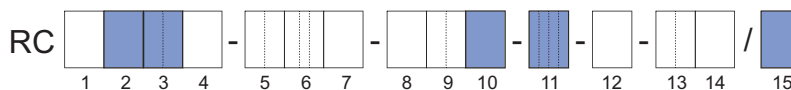

Tab. 14: Temperature classification

Temperature class	Maximum ambient temperature in °C (°F)		Maximum fluid temperature in °C (°F)
	Option L_...	Option Y_...	
T6	64 (147)	64 (147)	64 (147)
T5	79 (174)	79 (174)	79 (174)
T4	80 (176)	66 (150)	115 (239)
T3	68 (154)	51 (123)	178 (352)
T2	60 (140)	46 (114)	200 (392)
T1	60 (140)	46 (114)	200 (392)

Option Y_... not with model code pos. 11: FF11, FF12

Model code:

Pos. 2: H

Pos. 3: 50

Pos. 10: A, E, J

Pos. 11: _F21, _F22, FF11, FF12

Pos. 15: -

Ex code:

2.73.72.76.80.60

The following figure shows the relevant positions of the model code:

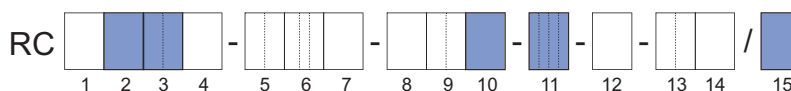

Tab. 15: Temperature classification

Temperature class	Maximum ambient temperature in °C (°F)		Maximum fluid temperature in °C (°F)
	Option L_...	Option Y_...	
T6	54 (129)	54 (129)	54 (129)
T5	68 (154)	68 (154)	68 (154)
T4	80 (176)	66 (150)	107 (224)
T3	68 (154)	51 (123)	176 (348)
T2	60 (140)	46 (114)	200 (392)
T1	60 (140)	46 (114)	200 (392)

Option Y_... not with model code pos. 11: FF11, FF12

Model code:

Pos. 2: H

Pos. 3: 50

Pos. 10: A, E, J

Pos. 11: _F21, _F22, FF11, FF12

Pos. 15: EPT

Ex code:

1.91.91.91.91.60

The following figure shows the relevant positions of the model code:

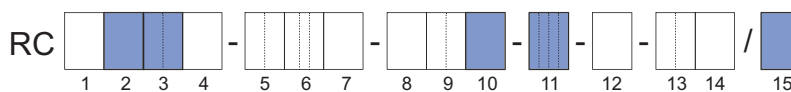

Tab. 16: Temperature classification

Temperature class	Maximum ambient temperature in °C (°F)		Maximum fluid temperature in °C (°F)
	Option L_...	Option Y_...	
T6	72 (161)	72 (161)	72 (161)
T5	80 (176)	77 (170)	87 (188)
T4	80 (176)	66 (150)	122 (251)
T3	64 (147)	49 (120)	187 (368)
T2	60 (140)	46 (114)	200 (392)
T1	60 (140)	46 (114)	200 (392)

Option Y_... not with model code pos. 11: FF11, FF12

Model code:

Pos. 2: H

Pos. 3: 80

Pos. 10: A, E, J

Pos. 11: _F21, FF11

Pos. 15: –

Ex code:

7.83.84.86.89.60

The following figure shows the relevant positions of the model code:

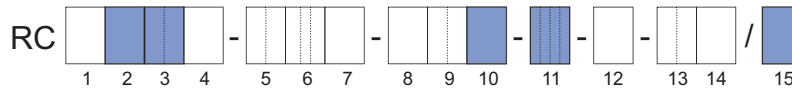

Tab. 17: Temperature classification

Temperature class	Maximum ambient temperature in °C (°F)		Maximum fluid temperature in °C (°F)
	Option L_...	Option Y_...	
T6	42 (107)	42 (107)	64 (147)
T5	57 (134)	57 (134)	80 (176)
T4	80 (176)	66 (150)	117 (242)
T3	66 (150)	50 (122)	185 (365)
T2	60 (140)	46 (114)	200 (392)
T1	60 (140)	46 (114)	200 (392)

Option Y_... not with model code pos. 11: FF11

Model code:

Pos. 2: H

Pos. 3: 80

Pos. 10: A, E, J

Pos. 11: _F22, FF12

Pos. 15: –

Ex code:

6.83.84.86.89.60

The following figure shows the relevant positions of the model code:

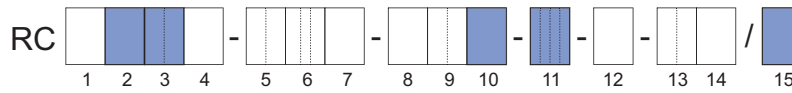

Tab. 18: Temperature classification

Temperature class	Maximum ambient temperature in °C (°F)		Maximum fluid temperature in °C (°F)
	Option L_...	Option Y_...	
T6	46 (114)	46 (114)	64 (147)
T5	61 (141)	61 (141)	80 (176)
T4	80 (176)	66 (150)	117 (242)
T3	66 (150)	50 (122)	185 (365)
T2	60 (140)	46 (114)	200 (392)
T1	60 (140)	46 (114)	200 (392)

Option Y_... not with model code pos. 11: FF12

Model code:

Pos. 2: H

Pos. 3: 25, 40

Pos. 10: A

Pos. 11: JF54, JF53

Ex code:

–

The following figure shows the relevant positions of the model code:

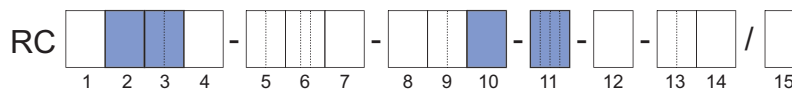

Tab. 19: Temperature classification

Temperature class	Maximum ambient temperature in °C		Maximum fluid temperature in °C
	Option L_...	Option Y_...	
T4	80	–	99
T3	74	–	162

Model code:

Pos. 2: H

Pos. 3: 50

Pos. 10: A, E

Pos. 11: JF54, JF53

Ex code:

-

The following figure shows the relevant positions of the model code:

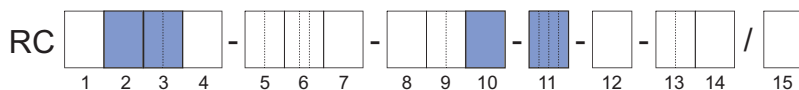

Tab. 20: Temperature classification

Temperature class	Maximum ambient temperature in °C		Maximum fluid temperature in °C
	Option L _{xxx}	Option Y _{xxx}	
T4	80	-	107
T3	68	-	176

Model code:

Pos. 2: H

Pos. 3: 80

Pos. 10: A, E

Pos. 11: JF54, JF53

Ex code:

-

The following figure shows the relevant positions of the model code:

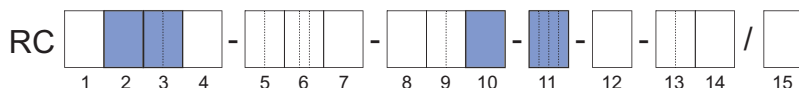

Tab. 21: Temperature classification

Temperature class	Maximum ambient temperature in °C		Maximum fluid temperature in °C
	Option L _{xxx}	Option Y _{xxx}	
T4	80	-	117
T3	66	-	185

6 Mechanical specification

6.1 Design

The Rotamass Hygienic flow meter is available with two design types:

- Integral type, sensor and transmitter are firmly connected
- Remote type with standard neck

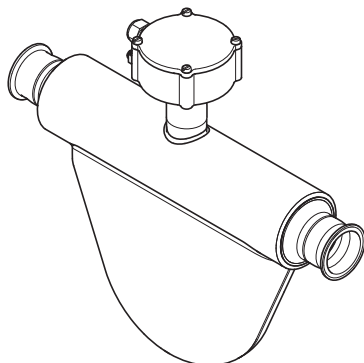
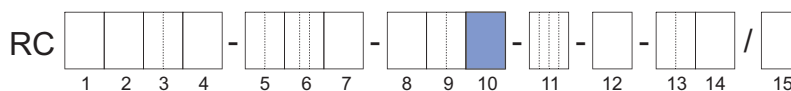

Fig. 20: Remote type sensor with standard neck



Design type	Design version	Process fluid temperature range	Model code position 10
Integral type	Direct connection	Standard	0, 2
Remote type	Standard neck		A, E, J



The design influences the temperature specification for Ex-approved Rotamass, see Explosion Proof Type Manual (IM 01U10X_--00_--R).

6.2 Material

6.2.1 Material wetted parts

For Rotamass Hygienic, wetted parts are available in stainless steel alloy. The measuring tubes used for manufacturing exhibits a surface roughness of $Ra \leq 0.8 \mu m$. Other parts as flow divider and process connections exhibit the same roughness.

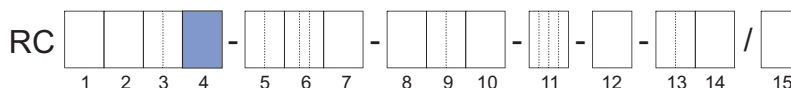

Material	Model code position 4
Stainless steel 1.4404/316L	S

6.2.2 Non-wetted parts

Housing material of sensor and transmitter are specified via model code position 7 and position 10.

Sensor housing material

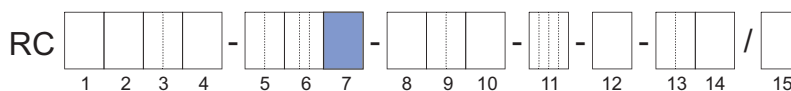

Housing material	Model code position 7
Stainless steel 1.4301/304, 1.4404/316L	0

Transmitter housing, coating and bracket material

The transmitter housing is available with different coatings:

- Standard coating
Urethane-cured polyester powder coating
- Corrosion protection coating
Three-layer coating with high chemical resistance (polyurethane coating on two layers of epoxy coating)

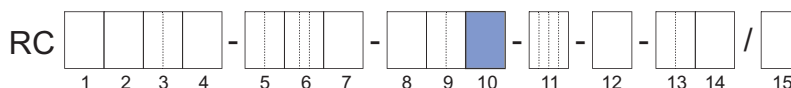

Housing material	Coating	Design type	Model code position 10	Bracket material
Aluminum Al-Si10Mg(Fe)	Standard coating	Integral type	0	–
		Remote type	A	Stainless steel 1.4404/316L
	Corrosion protection coating	Integral type	2	–
		Remote type	E	Stainless steel 1.4404/316L
Stainless Steel CF8M	–	Remote type	J	Stainless steel 1.4404/316L
	–			

See also *Design and housing* [▶ 105].

Nameplate

For stainless steel transmitter the nameplates are made of stainless steel 1.4404/316L. Aluminum transmitter and sensor nameplates are made of foil.

6.3 Process connections, dimensions and weights of sensor

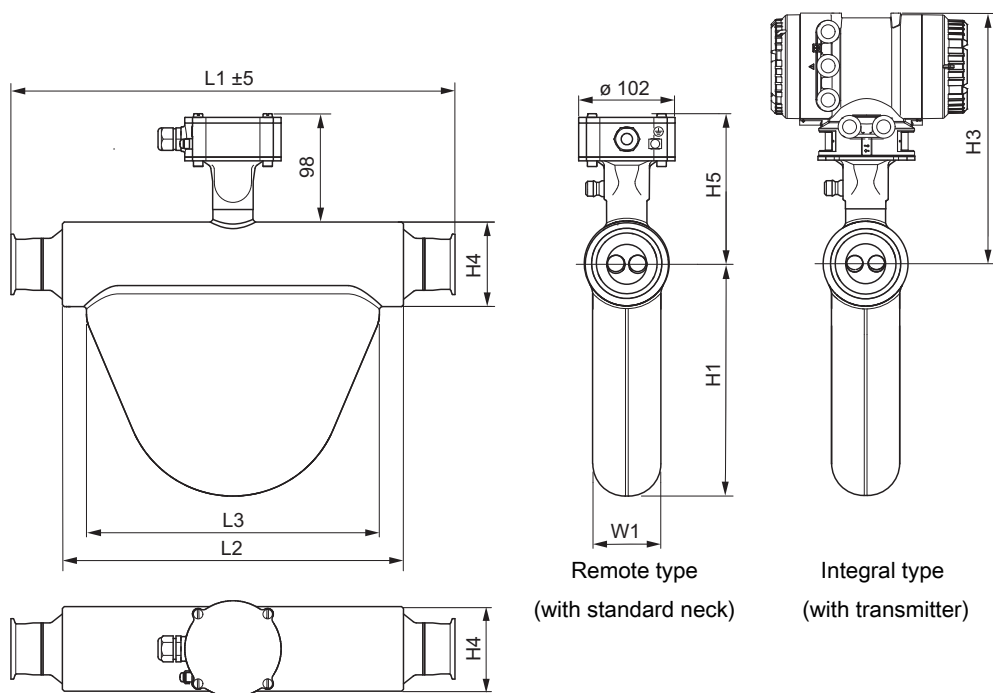

Fig. 21: Dimensions in mm

Tab. 22: Dimensions without length L1

Meter size	L2	L3	H1	H3	H4	H5	W1
	in mm (inch)						
Hygienic 25	190 (7.5)	165 (6.5)	117 (4.6)	268 (10.6)	56 (2.2)	138 (5.4)	42 (1.7)
Hygienic 40	227 (8.9)	195 (7.7)	145 (5.7)	277 (10.9)	71 (2.8)	148 (5.8)	50 (2)
Hygienic 50	361 (14.2)	310 (12.2)	245 (9.6)	289 (11.4)	90 (3.5)	159 (6.3)	72 (2.8)
Hygienic 80	455 (17.9)	400 (15.7)	333 (13.1)	296 (11.7)	102 (4)	167 (6.6)	96 (3.8)

Overall length L1 and weight

The overall length of the sensor depends on the selected process connection (type and size). The following tables list the overall length and weight as functions of the individual process connection.

The weights in the tables are for the remote type. Additional weight for the integral type: 3.5 kg (7.7 lb).

Threaded connection suitable for DIN 11851

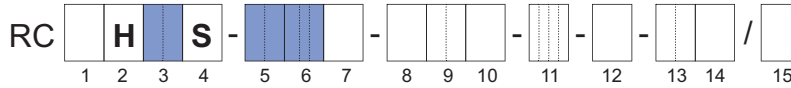

Tab. 23: Overall length L1 and weight of sensor (process connections: DIN 11851 threaded)

Process connections	Model code pos.		Hygienic 25		Hygienic 40		Hygienic 50		Hygienic 80	
	5	6	L1 in mm (inch)	Weight in kg (lb)	L1 in mm (inch)	Weight in kg (lb)	L1 in mm (inch)	Weight in kg (lb)	L1 in mm (inch)	Weight in kg (lb)
DIN 11851 DN25	25	HS2	280 (11)	5.4 (12)	320 (12.6)	7.4 (16)	–	–	–	–
DIN 11851 DN40	40		290 (11.4)	5.5 (12)	330 (13)	7.5 (17)	490 (19.3)	14.3 (32)	–	–
DIN 11851 DN50	50		–	–	–	–	480 (18.9)	14.4 (32)	610 (24)	23.4 (52)
DIN 11851 DN65	65		–	–	–	–	–	–	590 (23.2)	23.4 (52)
DIN 11851 DN80	80		–	–	–	–	–	–	590 (23.2)	23.8 (52)

Meaning of "–": not available

Clamp process connections according to DIN 32676 series A

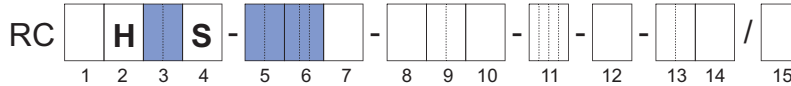

Tab. 24: Overall length L1 and weight of sensor (process connections: DIN 32676 series A clamp)

Process connections	Model code pos.		Hygienic 25		Hygienic 40		Hygienic 50		Hygienic 80	
	5	6	L1 in mm (inch)	Weight in kg (lb)	L1 in mm (inch)	Weight in kg (lb)	L1 in mm (inch)	Weight in kg (lb)	L1 in mm (inch)	Weight in kg (lb)
DIN 32676 series A DN25	25	HS4	280 (11)	5.2 (11)	320 (12.6)	7.2 (16)	–	–	–	–
DIN 32676 series A DN40	40		280 (11)	5.2 (11)	320 (12.6)	7.2 (16)	470 (18.5)	14 (31)	–	–
DIN 32676 series A DN50	50		–	–	–	–	470 (18.5)	14 (31)	600 (23.6)	22.9 (50)
DIN 32676 series A DN65	65		–	–	–	–	–	–	590 (23.2)	23 (51)
DIN 32676 series A DN80	80		–	–	–	–	–	–	590 (23.2)	23.1 (51)

Meaning of "–": not available

Clamp process connections according to DIN 32676 series C (Tri-Clamp)

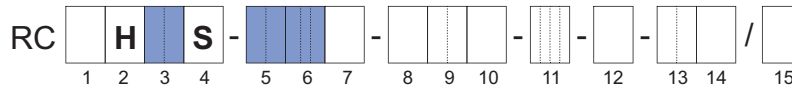

Tab. 25: Overall length L1 and weight of sensor (process connections: DIN 32676 series C Tri-Clamp)

Process connections	Model code pos.		Hygienic 25		Hygienic 40		Hygienic 50		Hygienic 80	
	5	6	L1 in mm (inch)	Weight in kg (lb)	L1 in mm (inch)	Weight in kg (lb)	L1 in mm (inch)	Weight in kg (lb)	L1 in mm (inch)	Weight in kg (lb)
DIN 32676 series C 1"	25	HS8	280 (11)	5.2 (12)	320 (12.6)	7.2 (16)	–	–	–	–
DIN 32676 series C 1½"	40		280 (11)	5.2 (11)	320 (12.6)	7.2 (16)	480 (18.9)	14 (31)	–	–
DIN 32676 series C 2"	50		–	–	–	–	470 (18.5)	14 (31)	600 (23.6)	22.9 (50)
DIN 32676 series C 2½"	65		–	–	–	–	–	–	580 (22.8)	22.8 (50)
DIN 32676 series C 3"	80		–	–	–	–	–	–	580 (22.8)	22.9 (50)

Meaning of "–": not available

Clamp process connection according to JIS/ISO 2852

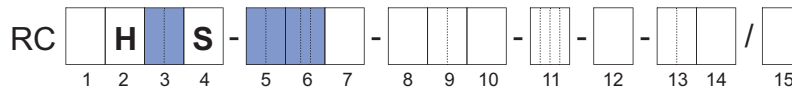

Tab. 26: Overall length L1 and weight of sensor (process connections: JIS/ISO 2852 clamp)

Process connections	Model code pos.		Hygienic 25		Hygienic 40		Hygienic 50		Hygienic 80	
	5	6	L1 in mm (inch)	Weight in kg (lb)	L1 in mm (inch)	Weight in kg (lb)	L1 in mm (inch)	Weight in kg (lb)	L1 in mm (inch)	Weight in kg (lb)
JIS/ISO 2852 1"	25	HS9	280 (11)	5.2 (11)	320 (12.6)	7.2 (16)	–	–	–	–
JIS/ISO 2852 1½"	40		280 (11)	5.2 (11)	320 (12.6)	7.2 (16)	480 (18.9)	14 (31)	–	–
JIS/ISO 2852 2"	50		–	–	–	–	470 (18.5)	14 (31)	600 (23.6)	22.9 (50)
JIS/ISO 2852 2½"	65		–	–	–	–	–	–	580 (22.8)	22.8 (50)
JIS/ISO 2852 3"	80		–	–	–	–	–	–	580 (22.8)	22.9 (50)

Meaning of "–": not available

6.4 Transmitter dimensions and weights

Transmitter dimensions

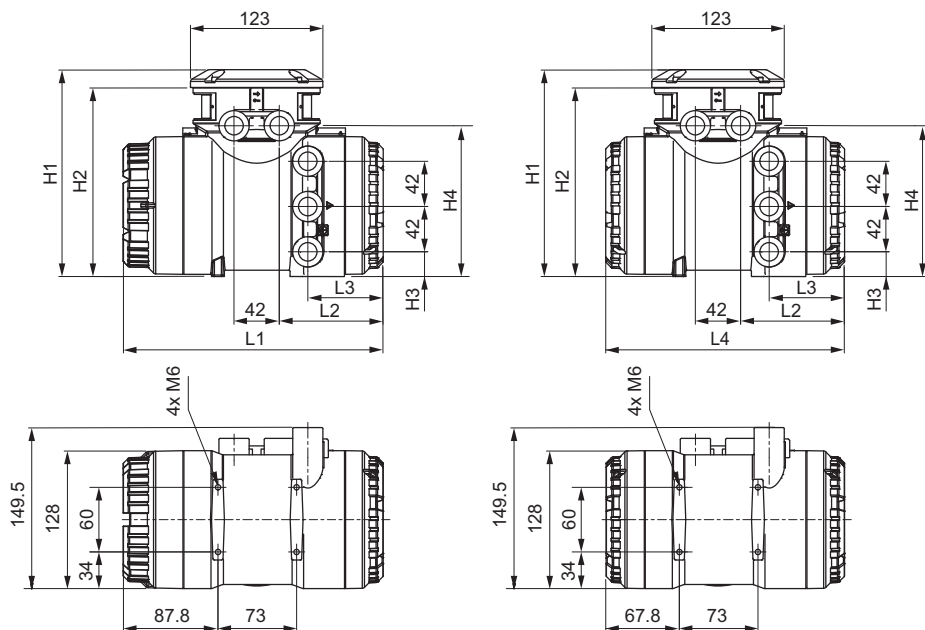

Fig. 22: Dimensions of transmitter in mm (left: transmitter with display, right: transmitter without display)

Tab. 27: Overall length L1 - L4 and height H1 - H4 of transmitter (material: stainless steel, aluminum)

Material	L1 in mm (inch)	L2 in mm (inch)	L3 in mm (inch)	L4 in mm (inch)	H1 in mm (inch)	H2 in mm (inch)	H3 in mm (inch)	H4 in mm (inch)
Stainless steel	255.5 (10.06)	110.5 (4.35)	69 (2.72)	235 (9.25)	201 (7.91)	184 (7.24)	24 (0.94)	150.5 (5.93)
Aluminum	241.5 (9.51)	96.5 (3.8)	70 (2.76)	221 (8.7)	192 (7.56)	175 (6.89)	23 (0.91)	140 (5.51)

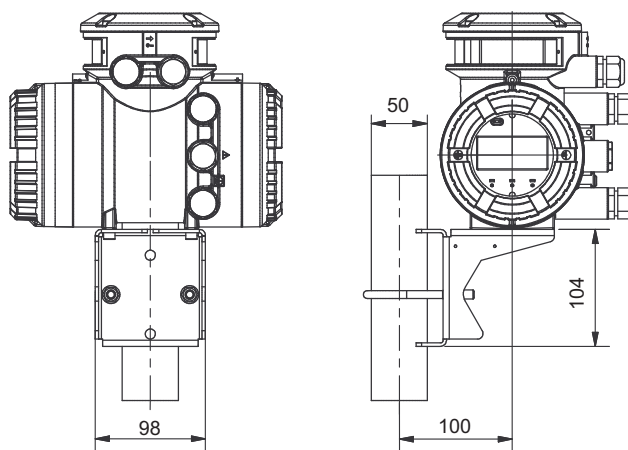
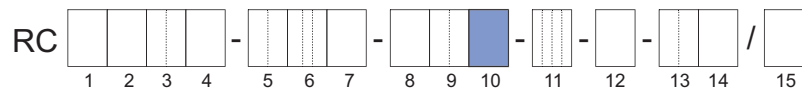

Fig. 23: Dimensions of transmitter in mm, attached to mounting bracket.



Transmitter weights

Model code (pos. 10)	Design type	Housing material of transmitter	Weight in kg (lb)
A, E	Remote	Aluminum	4.2 (9.3)
J		Stainless steel	12.5 (27.6)

7 Transmitter specification

Overview of functional scope of the Rotamass transmitter

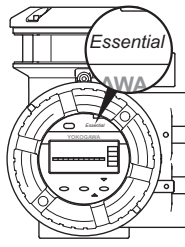
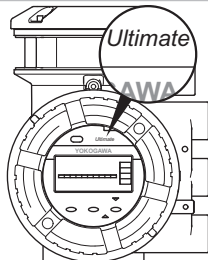
Functional scope	Transmitter	
	Essential	Ultimate
		
Model code (position 1)	E	U
4-line Dot-Matrix display	●	●
Universal power supply (V_{DC} and V_{AC})	●	●
microSD card	●	●
Installation		
Integral type	●	●
Remote type	●	●
Special functions		
Wizard	●	●
Event management	●	●
Total Health Check ¹⁾ (diagnostic function)	●	●
Dynamic pressure compensation ³⁾	–	●
Advanced functions		
Features on Demand	–	●
Standard concentration measurement	–	●
Advanced concentration measurement	–	●
Measurement of heat quantity ³⁾	–	●
Tube Health Check (diagnostic function)	●	●
Batching function ²⁾	–	●
Viscosity function ³⁾	–	●
Inputs and outputs		
Analog output	●	●
Pulse/frequency output	●	●
Status output	●	●
Analog input	–	●
Status input	●	●
Communication		
HART	●	●
Modbus	●	●
PROFIBUS PA	–	●

meaning of "–": not available;
meaning of "●": available

¹⁾ Function is based on external software (FieldMate)

²⁾ Only in combination with 1 or 2 status outputs

³⁾ Only in combination with an analog input or PROFIBUS PA

7.1 HART and Modbus

7.1.1 Inputs and outputs

Depending on the flow meter specification, there are different configurations of the connection terminal. Following are configuration examples of the connection terminal (value JK and M7 on model code position 13 - see *Communication type and I/O* [▶ 107] for details):

HART

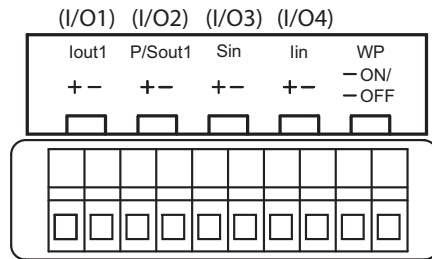

- I/O1: lout1 Current output (active/passive)
- I/O2: P/Sout1 Pulse or status output (passive)
- I/O3: Sin Status input
- I/O4: lin Current input (active/passive)
- WP: Write-protect bridge

Modbus

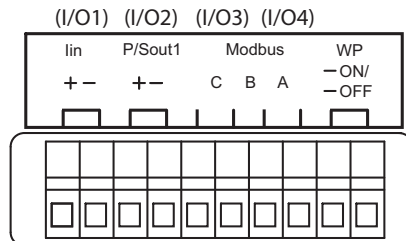

- I/O1: lin Current input (passive)
- I/O2: P/Sout1 Pulse or status output (passive)
- I/O3-I/O4: Modbus RS485 input/output
- WP: Write-protect bridge

7.1.1.1 Output signals

Galvanic isolation All circuits for inputs, outputs and power supply are galvanically isolated from each other.

Active current output *lout* One or two current outputs are available depending on model code position 13. Depending on the measured value, the active current output delivers 4 – 20 mA.

It may be used for output of the following measured values:

- Flow rate (mass, volume, net partial component flow of a mixture)
- Density
- Temperature
- Pressure
- Concentration

For HART communication devices, it is supplied on the current output *lout1*. The current output may be operated in compliance with the NAMUR NE43 standard.

	Value
Nominal output current	4 – 20 mA
Maximum output current range	2.4 – 21.6 mA
Load resistance	≤ 750 Ω
Load resistance for secure HART communication	230 – 600 Ω

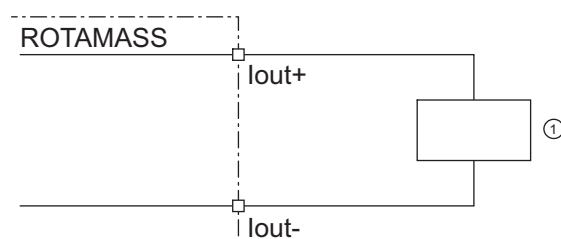

Fig. 24: Active current output connection *lout* HART

① Receiver

Passive current output *I_{out}*

	Value
Nominal output current	4 – 20 mA
Maximum output current range	2.4 – 21.6 mA
External power supply	10.5 – 32 V _{DC}
Load resistance for secure HART communication	230 – 600 Ω
Load resistance at current output	≤ 911 Ω

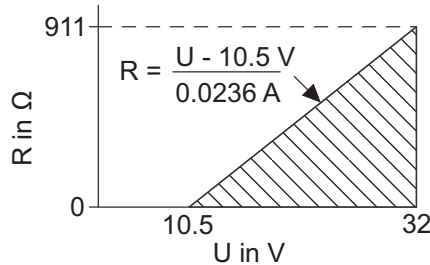

Fig. 25: Maximum load resistance as a function of an external power supply voltage

R Load resistance
 U External power supply voltage

The diagram shows the maximum load resistance R as a function of voltage U of the connected voltage source. Higher load resistances are allowed with higher power supply values. The usable zone for passive power output operation is indicated by the hatched area.

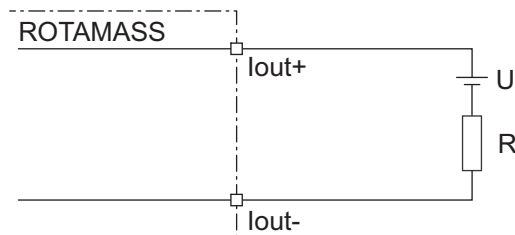

Fig. 26: Passive current output connection *I_{out}*

Analog output specification *I_{out}*

If mass- or volume flow is measured via current output *I_{out}* two additional deviation effects have to be taken into account.

- The *I_{out}* –base specification ΔI_{base} contains all combined effects of output adjustment, linearity, power supply variation, load resistance variation, short and long term drift for one year.
- The *I_{out}* –ambient temperature specification $\Delta I(T_{\text{amb}})$ gives an additional deviation effect if the ambient temperature of the transmitter differs from 20 °C.

Both additional output deviation effects have to be added to the basic massflow, or volume flow deviation. They are based on a 95 % (2σ) confidence level.

Deviation of mass- or volume flow by *I_{out}*

The following formula can be used to calculate the deviation of mass- or volume flow:

$$D_i = \sqrt{D^2 + \left(\frac{\Delta I_{base}}{I(Q)} \times 100 \%\right)^2 + \left(\frac{\Delta I(T_{amb})}{I(Q)} \times 100 \%\right)^2}$$

D_i	Maximum deviation of mass- or volume flow by <i>lout</i> in %
D	Maximum deviation of mass- or volume flow ¹⁾ by pulse/frequency output in %
$I(Q)$	<i>lout</i> depending on mass- or volume flow in μA
ΔI_{base}	Maximum deviation of <i>lout</i> by combined effects $\Delta I_{base} = a \times I(Q) + b$
$\Delta I(T_{amb})$	Maximum deviation of <i>lout</i> by deviation of the transmitter ambient temperature from 20 °C $\Delta I(T_{amb}) = (c \times I(Q) + d) \times (T - 20 \text{ °C})$
a, b, c, d	Constants

Description	Model code pos. 13	a in ppm	b in μA	c in ppm/°C	d in $\mu A/°C$
Non-intrinsically safe <i>lout</i> (active or passive)	JA, JB, JC, JD, JE, JF, JG, JH, JJ, JK, JL, JM, JN, M6	170	2.3	7	0
Intrinsically safe <i>lout</i> (passive)	JP, JQ, JR, JS				0.06

¹⁾Formula of volume flow accuracy D_v , please see chapter 4.6 *Volume flow accuracy* [22]

Active pulse output *P/Sout*

Connection of an electronic counter

Maximum voltage and correct polarity must be observed for wiring.

	Value
Load resistance	> 1 kΩ
Internal power supply	24 V _{DC} ±20 %
Maximum pulse rate	10000 pulses/s
Frequency range	0 – 12.5 kHz

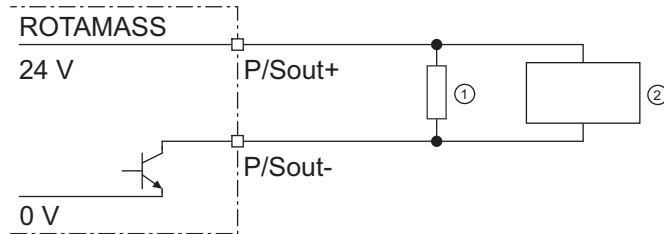

Fig. 27: Active pulse output connection *P/Sout*

- ① Load resistance
- ② Electronic counter

Connection of an electromechanical counter

	Value
Maximum current	150 mA
Average current	≤ 30 mA
Internal power supply	24 V _{DC} ±20 %
Maximum pulse rate	2 pulses/s
Pulse width	20, 33, 50, 100 ms

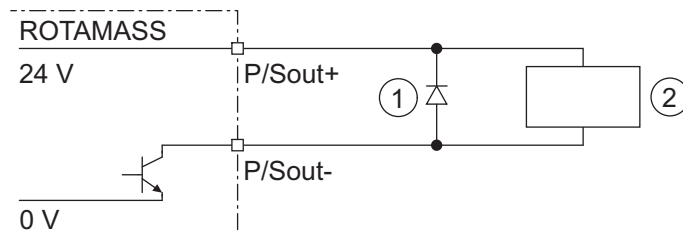

Fig. 28: Active pulse output *P/Sout* connection with electromechanical counter

- ① Protective diode
- ② Electromechanical counter

**Active pulse output
P/Sout with internal
pull-up resistor**

	Value
Internal power supply	24 V _{DC} ±20 %
Internal pull-up resistor	2.2 kΩ
Maximum pulse rate	10000 pulses/s
Frequency range	0 – 12.5 kHz

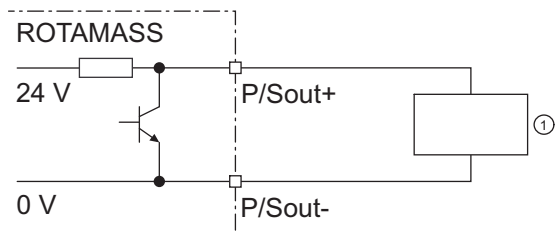

Fig. 29: Active pulse output P/Sout with internal pull-up resistor

① Electronic counter

Passive pulse output *P/Sout*

Maximum voltage and correct polarity must be observed for wiring.

	Value
Maximum load current	≤ 200 mA
Power supply	≤ 30 V _{DC}
Maximum pulse rate	10000 pulses/s
Frequency range	0 – 12.5 kHz

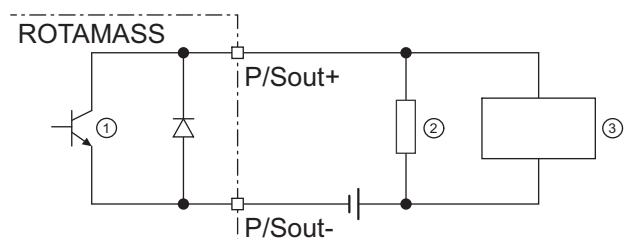

Fig. 30: Passive pulse output connection *P/Sout* with electronic counter

- ① Passive pulse or status output
- ② Load resistance
- ③ Electronic counter

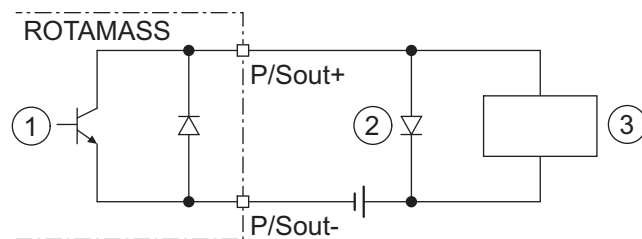

Fig. 31: Passive pulse output *P/Sout* connection with electromechanical counter

- ① Passive pulse or status output
- ② Protective diode
- ③ Electromechanical counter

Active status output P/Sout

Since this is a transistor contact, maximum allowed current as well as polarity and level of output voltage must be observed during wiring.

	Value
Load resistance	> 1 kΩ
Internal power supply	24 V _{DC} ±20 %

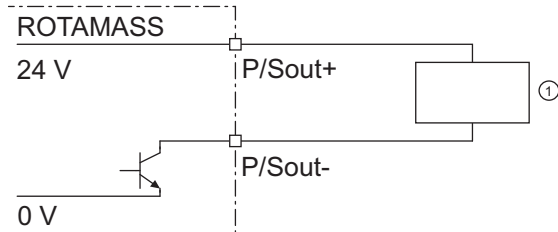

Fig. 32: Active status output connection P/Sout

① External device with load resistance

Active status output P/Sout with internal pull-up resistor

	Value
Internal pull-up resistor	2.2 kΩ
Internal power supply	24 V _{DC} ±20 %

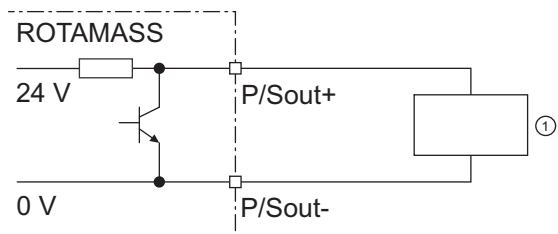

Fig. 33: Active status output P/Sout with internal pull-up resistor

① External device

Passive status output *P/Sout* or *Sout*

	Value
Output current	≤ 200 mA
Power supply	≤ 30 V _{DC}

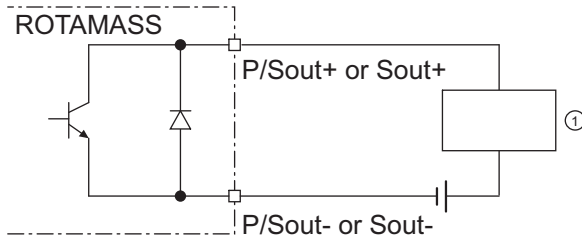

Fig. 34: Passive status output connection *P/Sout* or *Sout*

- ① External device

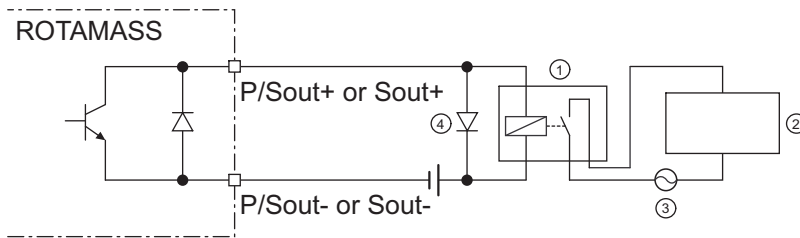

Fig. 35: Passive status output connection *P/Sout* or *Sout* for solenoid valve circuit

- ① Relay
- ② Solenoid valve
- ③ Magnetic valve power supply
- ④ Protective diode

A relay must be connected in series to switch alternating voltage.

Passive pulse or status output *P/Sout* (NAMUR)

Output signals according to EN 60947-5-6 (previously NAMUR, worksheet NA001):

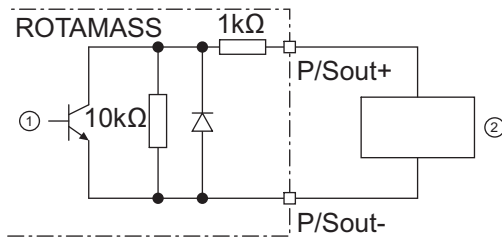

Fig. 36: Passive pulse or status output with switching amplifier connected in series

- ① Passive pulse or status output
- ② Switching amplifier

7.1.1.2 Input signals

Active current input *lin*

An individual analog power input is available for external analog devices.

The active current input *lin* is provided for connecting a two-wire transmitter with an output signal of 4 – 20 mA.

	Value
Nominal input current	4 – 20 mA
Maximum input current range	2.4 – 21.6 mA
Internal power supply	24 V _{DC} ±20 %
Internal load resistance Rotamass	≤ 160 Ω

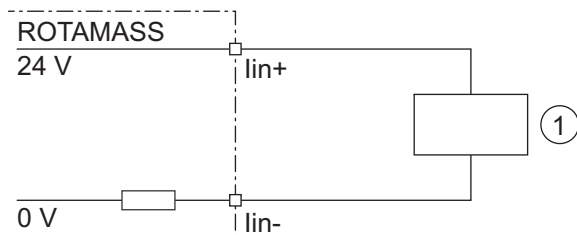

Fig. 37: Connection of external device with passive current output

① External passive current output device

Passive current input *lin*

The passive current input *lin* is provided for connecting a four-wire transmitter with an output signal of 4 – 20 mA.

	Value
Nominal input current	4 – 20 mA
Maximum input current range	2.4 – 21.6 mA
Maximum input voltage	≤ 32 V _{DC}
Internal load resistance Rotamass	≤ 160 Ω

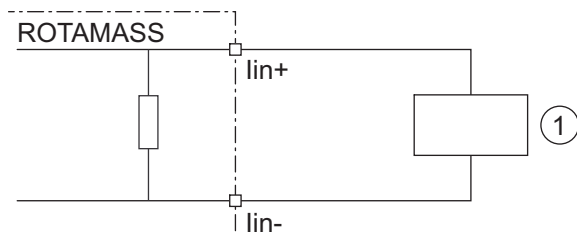

Fig. 38: Connection of external device with active current output

① External active current output device

Status input *Sin*



Do not connect a signal source with electric voltage.

The status input is provided for use of voltage-free contacts with the following specification:

Switching status	Resistance
Closed	< 200 Ω
Open	> 100 kΩ

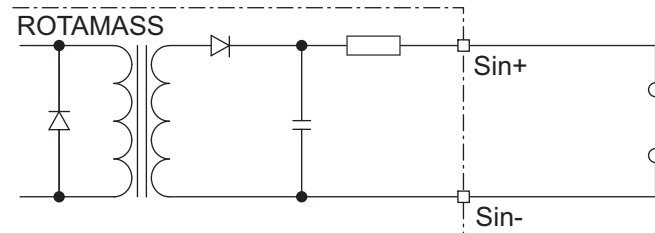

Fig. 39: Status input connection

7.2 PROFIBUS PA

7.2.1 Overview of functional scope

Output signal:		
Digital communication signal based on PROFIBUS PA protocol (Profile Revision R3.02 Compliant)		
PROFIBUS PA block specifications:		
▪ Transducer block (TB):		
	Flow Transducer Block (FTB)	•
	Concentration Transducer Block (CTB)	optional
	LCD Indicator Transducer Block (LTB)	•
	Maintenance Transducer Block (MTB)	•
	Advanced Diagnostic Transducer Block (ADTB)	optional
▪ Analog Input block (AI):¹⁾		
	AI1: Mass flow	•
	AI2: Density	•
	AI3: Temperature	•
	AI4: Volume flow	•
	AI5: Reference density	•
	AI6: Corrected volume flow	•
▪ Totalizer block (TOT):¹⁾		
	TOT1: Mass	•
	TOT2: Volume	•
	TOT3: Corrected volume flow	•
▪ Analog output block (AO):¹⁾		
	AO: Pressure	•
▪ Profile Revision R3.02:		
	Condensed Status (NE 107)	•
	Life Cycle Management (Automatic IDENT_NUMBER adaptation)	•
▪ DP-V0 cyclic data:		
	AI x 6, TOT x 3, AO x 1	•
▪ IDENT NUMBER:		
	0x45A0 (manufacturer specific)	•
	0x9740, 0x9741, 0x9742 (profile specific)	•
▪ GSD:		
	YEC45A0.gsd, pa139740.gsd, pa139741.gsd, pa139742.gsd	•
Conditions of Communication Line:		
Supply voltage from the Bus:	9 to 32 V _{DC}	•
Current draw:	15 mA (maximum)	•
Bus address switch:		
via Hardware address switch or via Software		

Alarm selection function:
These informations are indicated in DIAGNOSTICS parameter, which can be handled during normal operation.
Displayed language:
In the case of PROFIBUS PA communication type, different language packages are possible to choose.

1) Factory default setting; can be changed by parameter "Channel".

meaning of "●": available

7.2.2 Inputs and outputs

For the PROFIBUS PA version there is only one configuration of the connection terminal. Following is the configuration of the connection terminal (value G0 and G1 on model code position 13, see *Communication type and I/O* [107] for details):

PROFIBUS PA

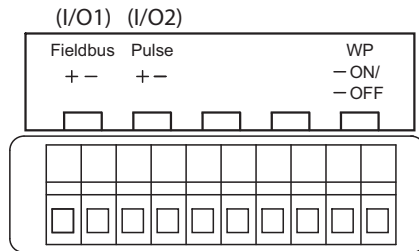

- I/O1: Fieldbus PROFIBUS PA communication
- I/O2: Pulse Pulse / Frequency output
- WP: Write-protect bridge

7.2.2.1 Output signals PROFIBUS PA

Digital communication signal based on PROFIBUS PA protocol.
Maximum voltage and correct polarity must be observed for wiring.

	Value
Power supply	9 to 32 V _{DC}
Current draw	15 mA (maximum)

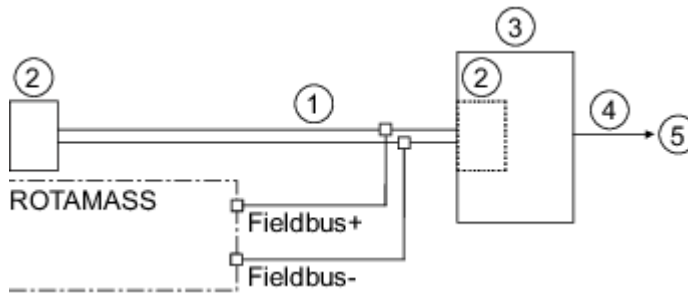

Fig. 40: PROFIBUS PA connection

- ① PROFIBUS PA
- ② Termination
- ③ DP/PA-Coupler
- ④ PROFIBUS DP
- ⑤ Host

Passive pulse output (only for calibration)

	Value
Maximum load current	≤ 200 mA
Power supply	≤ 30 V _{DC}
Maximum pulse rate	10000 pulses/s
Frequency range	0 – 12.5 kHz

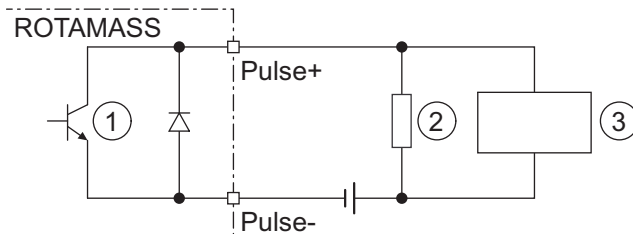

Fig. 41: Passive pulse output connection with electronic counter

- ① Passive pulse
- ② Load resistance
- ③ Electronic counter

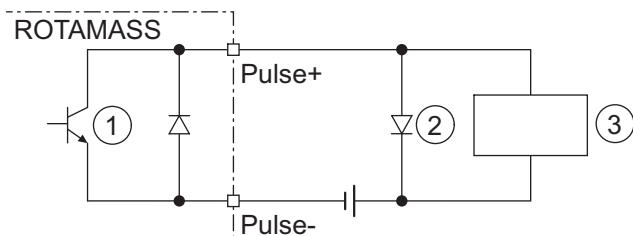

Fig. 42: Passive pulse output connection with electromechanical counter

- ① Passive pulse
- ② Protective diode
- ③ Electromechanical counter

7.3 Power supply

Power supply

Alternating-current voltage (rms):

- Power supply¹⁾: 24 V_{AC} +20 % -15 % or 100 – 240 V_{AC} +10 % -20 %
- Power frequency: 47 – 63 Hz

Direct-current voltage:

- Power supply¹⁾: 24 V_{DC} +20 % -15 % or 100 – 120 V_{DC} +8,3 % -10 %

¹⁾ for option MC_ (DNV GL approval) supply voltage is limited to 24 V; in addition NE21 testing indicates a tolerable area of 24 V_{DC} ±20 % under NE21 test conditions.

Power consumption

$P \leq 10$ W (including sensor)

Power supply failure

In the event of a power failure, the flow meter data are backed up on a non-volatile internal memory. In case of devices with display, the characteristic sensor values, such as nominal diameter, serial number, calibration constants, zero point, etc. and the error history are also stored on a microSD card.

7.4 Cable specification

With the remote type, the original connecting cable from Rota Yokogawa must be used to connect the sensor with the transmitter. The connecting cable included in the delivery may be shortened. An assembly set along with the appropriate instructions are enclosed for this purpose.

The connecting cable can be ordered as option in various lengths as a standard type (device options L_ _ _) or as marine approved fire retardant cable (device options Y_ _ _), see chapters *Connecting cable type and length* [▶ 111] and *Marine approval* [▶ 116] for details.



The maximum cable length to keep the specification is 30 m (98.4 ft). Longer cables must be ordered as a separate item. For this purpose please check the "Customers Maintenance Parts List" (Ref.: CMPL 01U10B00-00EN-R) or consult our Yokogawa Service team.

8 Advanced functions and Features on Demand (FOD)

Rotamass Total Insight includes many dedicated application and maintenance functions that can be ordered simultaneously with the device or can be purchased and activated in a second time (Features on Demand).

Advanced functions

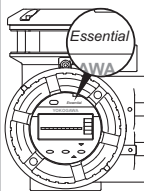
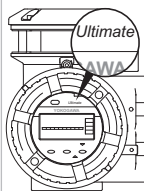
Functional scope	Transmitter		Communication type and I/O			Mandatory I/O
	Essential	Ultimate	Available type			
			HART	Modbus	PROFIBUS PA	
Model code (pos. 1 and pos. 13)	E	U	J_	M_	G_	
Standard concentration measurement	-	•	•	•		
Advanced concentration measurement	-	•	•	•	•	Not applicable
Tube Health Check	•	•	•	•		
Batching function	-	•	•	-	•	1 status output for one-stage batching 2 status outputs for two-stage batching
Viscosity function	-	•	•	-	-	1 analog input for J_
Measurement of heat quantity	-	•	•	•	•	1 analog input for J_ and M_

meaning of "-": not available;
meaning of "•": available

8.1 Concentration and petroleum measurement

Standard concentration measurement

The standard concentration measurement (option CST) can be used for concentration measurements of emulsions or suspensions when density of the fluid involved depends only on temperature.

The standard concentration measurement can also be used for many low-concentration solutions if there is only minor interaction between the liquids or if the miscibility is negligible. For questions regarding a specific application, contact the responsible Yokogawa sales organization. The appropriate density coefficients must be determined prior to using this option and input into the transmitter. To do so, the recommendation is to determine the necessary parameters from density data using DTM in the Yokogawa FieldMate program or the calculation tool included in the delivery.

Advanced concentration measurement

The advanced concentration measurement (option AC_) is recommended for more complex applications, such as for liquids that interact.

Following is a table that lists possible pre-configured concentrations. The desired data sets must be requested by the customer to the Yokogawa sales organization at the time the order is placed. The customer is responsible to ensure chemical compatibility of the material of the wetted parts with the measured chemicals. For strong acids or oxidizers which attack steel pipes a variant with wetted parts made of Ni alloy C-22/2.4602 is necessary.

Set	Fluid A / B	Concentration range	Unit	Temperature range in °C	Density range in kg/l	Data source for density data
C01	Sugar / Water	0 – 85	°Bx	0 – 80	0.97 – 1.45	PTB... Messages 100 5/90: "The density of watery sucrose solutions after the introduction of the international temperature scale of 1990 (ITS1990)" Table 5
C02 ¹⁾	NaOH / Water	0 – 54	WT%	0 – 100	0.95 – 1.58	D'Ans-Lax, Handbook for chemists and physicists Vol.1, 3rd edition, 1967
C03	KOH / Water	1 – 55	WT%	54 – 100	1.01 – 1.58	D'Ans-Lax, Handbook for chemists and physicists Vol.1, 3rd edition, 1967
C04	NH ₄ NO ₃ / Water	1 – 50	WT%	0 – 80	0.97 – 1.24	Table of density data on request
C05	NH ₄ NO ₃ / Water	20 – 70	WT%	20 – 100	1.04 – 1.33	Table of density data on request
C06 ¹⁾	HCl / Water	22 – 34	WT%	20 – 60	1.08 – 1.17	D'Ans-Lax, Handbook for chemists and physicists Vol.1, 3rd edition, 1967
C07	HNO ₃ / Water	50 – 67	WT%	10 – 60	1.26 – 1.40	Table of density data on request
C09 ¹⁾	H ₂ O ₂ / Water	30 – 75	WT%	4.5 – 43.5	1.00 – 1.20	Table of density data on request
C10 ¹⁾	Ethylene glycol / Water	10 – 50	WT%	-20 – 40	1.005 – 1.085	Table of density data on request
C11	Starch / Water	33 – 42.5	WT%	35 – 45	1.14 – 1.20	Table of density data on request
C12	Methanol / Water	35 – 60	WT%	0 – 40	0.89 – 0.96	Table of density data on request
C20	Alcohol / Water	55 – 100	VOL%	10 – 40	0.76 – 0.94	Table of density data on request
C21	Sugar / Water	40 – 80	°Bx	75 – 100	1.15 – 1.35	Table of density data on request
C30	Alcohol / Water	66 – 100	WT%	15 – 40	0.77 – 0.88	Standard Copersucar 1967
C37	Alcohol / Water	66 – 100	WT%	10 – 40	0.772 – 0.885	Brazilian Standard ABNT

¹⁾ We recommend using devices with wetted parts made of nickel alloy C22. Contact the Yokogawa sales organization about availability.

¹⁾ Maximum 4 C_ option sets can be ordered for one device simultaneously.

For details about the ordering information, see *Concentration and petroleum measurement* [▶ 112].

8.2 Batching function

Batching and filling processes are typical applications in different industries as food and beverage, cosmetic, pharmaceutical, chemical and oil & gas.

Rotamass Total Insight offers an integrated “Batching function” to automatize the task. A “self-learning” algorithm optimizes the process and allows high accurate results.

The function supports two filling modes:

- one-stage mode with single valve
- two-stage mode to control two valves for accurate filling

Without using an external flow computer, data related to the process can be transmitted via communication protocol. The error management function allows the user to set alarms and warnings accordingly the application needs.

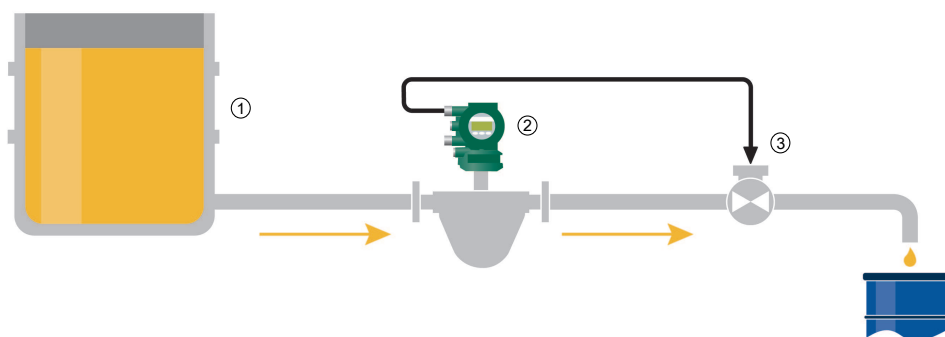

Fig. 43: One-stage mode (The above diagram illustrates the fundamental functionality for one of several combination possibilities)

- | | |
|--------------------------|---------|
| ① Storage tank | ③ Valve |
| ② Rotamass Total Insight | |

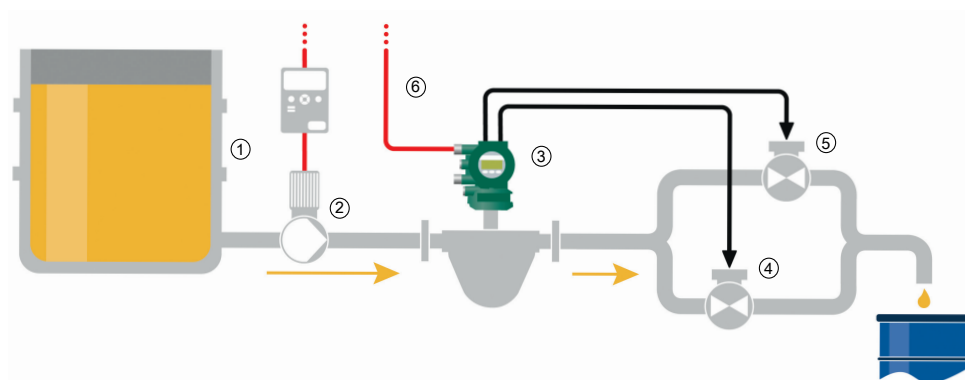

Fig. 44: Two-stage mode (The above diagram illustrates the fundamental functionality for one of several combination possibilities)

- | | |
|--------------------------|-------------|
| ① Storage tank | ④ Valve "A" |
| ② Pump | ⑤ Valve "B" |
| ③ Rotamass Total Insight | ⑥ HART |

For details about the ordering information, see *Batching function* [▶ 112].

8.3 Viscosity function

The Viscosity function allows the user to have an estimation of the viscosity of the fluid.

The function can be used as redundant viscosity control or as reference value to activate other processes like for instance fluid heating systems.

The viscosity estimation is calculated based on a comparison between measured pressure loss Δp and a “calculated” Δp_{cal} between two points of the pipe nearby the flow meter (refer to related instruction manual for the correct installation).

In order to use the function a pressure measurement device (separate order) directly connected to the analog input of the Rotamass Total Insight is necessary. Based on iteration process, Rotamass Total Insight finds the value of viscosity μ that returns a Δp_{cal} closed to the measured Δp .

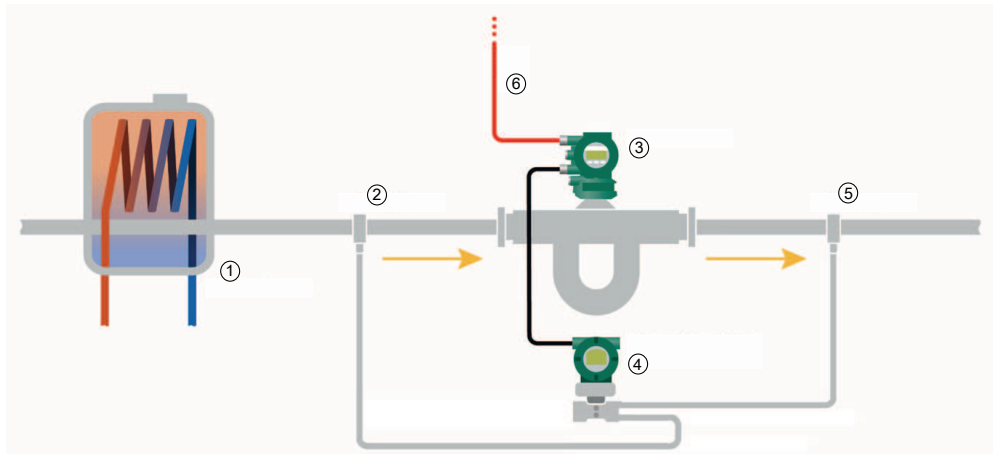

Fig. 45: Positioning of pressure taps

- | | | | |
|---|------------------------|---|-----------------------------------|
| ① | Heat exchanger | ④ | Differential pressure transmitter |
| ② | Pressure tap 1 | ⑤ | Pressure tap 2 |
| ③ | Rotamass Total Insight | ⑥ | HART |

Application example:

In this application example the Viscosity function returns a reference value used to activate a heating system and the Rotamass Total Insight is using HART communication.

For details about the ordering information, see *Viscosity function* [▶ 112].

8.4 Tube Health Check

General	<p>The Tube Health Check function is a valuable diagnostic function to evaluate the status of the measuring tubes of Rotamass Total Insight.</p> <p>For details about the ordering information, see <i>Tube Health Check</i> [▶ 115].</p>
Tube integrity	<p>The function is able to measure periodically the change of the stiffness of the measuring tubes and gives the possibility to set up a real predictive maintenance system or to detect corrosion or clogging of the measuring tubes. The measurement values can be stored in the internal microSD card or transmitted via HART, Modbus or PROFIBUS PA protocol and therefore integrated in the customers condition monitoring system.</p> <p>An alarm or an external event can be activated directly from Rotamass Total Insight in case the measured value exceeds a threshold defined by the user. The single measurements can be plotted in a diagram and printed in a report for quality and maintenance documentation by using the Yokogawa Device Management Software FieldMate.</p>
Dry Verification for Russia	<p>With Rotamass Total Insight and the Tube Health Check function customers in Russia can benefit from the Dry Verification procedure. The Dry Verification procedure is described in the verification method document (МП 208-053-2019). It determines the error of the flow measurement of the device. When Dry Verification test (tube stiffness change) results are within the required specifications it is not necessary to dispatch the flow meter to an external flow laboratory for verification. For Dry Verification please order Tube Health Check in combination with option VR.</p>

8.5 Measurement of heat quantity

The function allows to evaluate the total fuel calorific value of the measured fluid. The function can work with a constant value of the calorific value of the fluid, but in order to have a precise evaluation we suggest to use an additional device like a gas chromatograph (not included in the supply). The external device that supplies the instantaneous calorific value is connected with the current input of the transmitter. Based on the mass flow, the total calorific energy of the fluid is calculated as below:

Formula for total calorific energy

$$\sum E_{cal} = \sum (Q_m \times H_i \times \Delta t)$$

E_{cal}	Calorific energy
Q_m	Mass flow rate
H_i	Calorific value variable
Δt	Time interval between two measurements

Other formula based on volume and corrected volume are included in the function and can be set using the display or the configuration PC software FieldMate.

For details about the ordering information, see *Measurement of heat quantity* [▶ 116].

8.6 Features on Demand (FOD)

In combination with the “Ultimate” transmitter, the functions can be purchased and activated later as “Features on Demand”.

After the order, the user receives a KeyCode for input in the transmitter. To activate the desired functions, refer to related software instruction manual (IM01U10S0_-00_-R).

The options of FOD functions for Rotamass Total Insight are shown below.

To order these functions refer to the related general specifications for FOD functions (GS01U10B20-00_-R).

Option category	Options	Description	Valid from main SW rev. ¹⁾		
			Modbus	HART	PROFIBUS PA
Concentration and petroleum measurement	CST	Standard concentration measurement	R1.01.01	R1.01.02	R1.01.01
	AC0	Advanced concentration measurement, customer settings			
Batching function	BT	Batching and filling function	-	R3.01.01	-
Viscosity function	VM	Viscosity computing function for liquids			R1.01.01
Measurement of heat quantity	CGC	Measurement of the total transported energy content of a fuel in connection with a sensor for determining the fuel's calorific value (e.g. a gas chromatograph, not included in scope of delivery).	R1.01.01	R1.01.02	R1.01.01
Tube Health Check	TC	Tube Health Check	R1.01.01	R1.01.02 ²⁾	R1.01.01

¹⁾ Main software revision is given by the transmitter for which the FODs are intended for. For details refer to software instruction manual (IM01U10S0_-00_-R).

²⁾ From HART software rev. R3.01.01 Tube Health Check includes trend line report (by FieldMate) and the possibility to store the data on microSD card.

Please be sure that your device is compatible with the selected function and in case of doubts please contact Yokogawa Service Department providing the serial number or the model code of the target device.

9 Approvals and declarations of conformity

CE marking	The Rotamass Total Insight meets the statutory requirements of the applicable EU Directives. By attaching the CE mark, Rota Yokogawa confirms conformity of the field instrument with the requirements of the applicable EU Directives. The EU Declaration of Conformity is enclosed with the product on a data carrier.
RCM	Rotamass Total Insight meets the EMC requirements of the Australian Communications and Media Authority (ACMA).
Ex approvals	All data relevant for explosion protection are included in separate Explosion Proof Type Manuals.
NACE	Chemical composition of wetted materials 316L/316/1.4404/1.4401/1.4435 and Ni-Alloy C-22/2.4602 is conform to: <ul style="list-style-type: none"> ▪ ANSI / NACE-MR0175 / ISO15156-2 ▪ ANSI / NACE-MR0175 / ISO15156-3 ▪ NACE MR0103 <p>For details please see Rota Yokogawa declaration about NACE conformity 8660001.</p>
Pressure equipment approvals	The Rotamass Total Insight is in compliance with the statutory requirements of the applicable EU Pressure Equipment Directive (PED) for fluid groups 1 and 2. <p>The customer is fully responsible of selecting proper materials which withstand corrosive or erosive conditions. In case of heavy corrosion and/or erosion the instrument may not withstand the pressure and an incident may happen with human and/or environmental harm. Yokogawa will not take any liability regarding damage caused by corrosion or erosion. If corrosion or erosion may happen, the user has to check periodically if the necessary wall thickness is still in place.</p>
Functional safety	The Rotamass Total Insight with HART communication type complies with the relevant safety management requirements of IEC 61508:2010 SIL3. The Rotamass Total Insight product families can be used to implement a SIL 2 safety function (with HFT = 0) or a SIL 3 safety function (with HFT = 1) with all its 4 – 20 mA outputs. The available number of outputs depends on the model code. For further information please contact Yokogawa sales department or visit: <p>http://www.exida.com/SAEL-Safety/yokogawa-electric-corporation-rotamass-ti-series</p>

Tab. 28: Approvals and certifications

Type	Approval or certification
ATEX	<p>EU Directive 2014/34/EU</p> <p>ATEX approval:</p> <p>DEKRA 15ATEX0023 X</p> <p>CE₀₃₄₄ II2G or II2(1)G or II2D or II2(1)D</p> <p>Applied standards:</p> <ul style="list-style-type: none"> ▪ EN 60079-0 +A11 ▪ EN 60079-1 ▪ EN 60079-7 ▪ EN 60079-11 ▪ EN 60079-31
	<p>Remote transmitter (depending on the model code):</p> <p>Ex db [ia Ga] IIC T6 Gb or Ex db eb [ia Ga] IIC T6 Gb or Ex db [ia Ga] IIB T6 Gb or Ex db eb [ia Ga] IIB T6 Gb Ex db [ia Ga] [ia IIC Ga] IIB T6 Gb or Ex db eb [ia Ga] [ia IIC Ga] IIB T6 Gb or Ex tb [ia Da] IIIC T75 °C Db</p>
	<p>Remote sensor (depending on the model code):</p> <p>Ex ib IIC T6...T1 Gb or Ex ib IIB T6...T1 Gb Ex ib IIIC T200 °C Db</p>
	<p>Integral type (depending on the model code):</p> <p>Ex db ib IIC T6...T1 Gb or Ex db eb ib IIC T6...T1 Gb or Ex db ib IIB T6...T1 Gb or Ex db eb ib IIB T6...T1 Gb or Ex db ib [ia Ga] IIC T6...T1 Gb or Ex db eb ib [ia Ga] IIC T6...T1 Gb or Ex db ib [ia IIC Ga] IIB T6...T1 Gb or Ex db eb ib [ia IIC Ga] IIB T6...T1 Gb Ex ib tb IIIC T150 °C Db or Ex ib tb [ia Da] IIIC T150 °C Db</p>

Type	Approval or certification
IECEX	IECEx approval: IECEx DEK 15.0016X Applied standards: <ul style="list-style-type: none"> ▪ IEC 60079-0 ▪ IEC 60079-1 ▪ IEC 60079-7 ▪ IEC 60079-11 ▪ IEC 60079-31
	Remote transmitter (depending on the model code): Ex db [ia Ga] IIC T6 Gb or Ex db eb [ia Ga] IIC T6 Gb or Ex db [ia Ga] IIB T6 Gb or Ex db eb [ia Ga] IIB T6 Gb Ex db [ia Ga] [ia IIC Ga] IIB T6 Gb or Ex db eb [ia Ga] [ia IIC Ga] IIB T6 Gb or Ex tb [ia Da] IIIC T75 °C Db
	Remote sensor (depending on the model code): Ex ib IIC T6...T1 Gb or Ex ib IIB T6...T1 Gb Ex ib IIIC T200 °C Db
	Integral type (depending on the model code): Ex db ib IIC T6...T1 Gb or Ex db eb ib IIC T6...T1 Gb or Ex db ib IIB T6...T1 Gb or Ex db eb ib IIB T6...T1 Gb or Ex db ib [ia Ga] IIC T6...T1 Gb or Ex db eb ib [ia Ga] IIC T6...T1 Gb or Ex db ib [ia IIC Ga] IIB T6...T1 Gb or Ex db eb ib [ia IIC Ga] IIB T6...T1 Gb Ex ib tb IIIC T150 °C Db or Ex ib tb [ia Da] IIIC T150 °C Db

Type	Approval or certification
FM (CA/US)	<p>FM approvals:</p> <ul style="list-style-type: none"> ▪ US Cert No. FM16US0095X ▪ CA Cert No. FM16CA0031X <p>Applied standards:</p> <ul style="list-style-type: none"> ▪ Class 3600 ▪ Class 3610 ▪ Class 3615 ▪ Class 3810 ▪ Class 3616 ▪ NEMA 250 ▪ ANSI/IEC 60529 ▪ CSA-C22.2 No. 0-10 ▪ CSA-C22.2 No. 0.4-04 ▪ CSA-C22.2 No. 0.5-1982 ▪ CSA-C22.2 No. 94.1-07 ▪ CSA-C22.2 No. 94.2-07 ▪ CAN/CSA-C22.2 No. 60079-0 ▪ CAN/CSA-C22.2 No. 60079-11 ▪ CAN/CSA-C22.2 No. 61010-1-04 ▪ CSA-C22.2 No. 25-1966 ▪ CSA-C22.2 No. 30-M1986 ▪ CSA-C22.2 No. 60529
	<p>Remote transmitter (depending on the model code):</p> <p>CL I, DIV 1, GP ABCD, CL II/III, DIV 1, GP EFG; CL I ZN 1 GP IIC; Associated Apparatus CL I/II/III DIV 1, GP ABCDEFG; CL I ZN 0 GP IIC Entity Temperature class T6</p> <p>or</p> <p>CL I, DIV 1, GP ABCD, CL II/III, DIV 1, GP EFG; CL I ZN 1 GP IIC; Associated Apparatus CL I/II/III DIV 1, GP ABCDEFG; CL I ZN 0 GP IIC Temperature class T6; Associated Apparatus CL I/II/III DIV 1, GP ABCDEFG; CL I ZN 0 GP IIC Entity Temperature class T6</p>
	<p>or</p> <p>CL I, DIV 1, GP CD, CL II/III, DIV 1, GP EFG; CL I ZN 1 GP IIB; Associated Apparatus CL I/II/III DIV 1, GP CDEFG; CL I ZN 0 GP IIB Entity Temperature class T6</p> <p>or</p> <p>CL I, DIV 1, GP CD, CL II/III, DIV 1, GP EFG; CL I ZN 1 GP IIB; Associated Apparatus CL I/II/III DIV 1, GP CDEFG; CL I ZN 0 GP IIB Temperature class T6; Associated Apparatus CL I/II/III DIV 1, GP ABCDEFG; CL I ZN 0 GP IIB Entity Temperature class T6</p>
	<p>Remote sensor (depending on the model code):</p> <p>IS CL I/II/III, DIV 1, GP ABCDEFG; CL I, ZN 0, GP IIC Temperature class T*</p> <p>or</p> <p>IS CL I/II/III, DIV 1, GP ABCDEFG; CL I, ZN 0, GP IIB Temperature class T*</p>

Type	Approval or certification
FM (CA/US)	<p>Integral type (depending on the model code): CL I, DIV 1, GP ABCD, CL II/III, DIV 1, GP EFG; CL I ZN 1 GP IIC Temperature class T*</p> <p>or</p> <p>CL I, DIV 1, GP ABCD, CL II/III, DIV 1, GP EFG; CL I ZN 1 GP IIC Associated Apparatus CL I/II/III DIV 1 GP ABCDEFG; CL I ZN 0 GP IIC Entity Temperature class T*</p> <p>or</p> <p>CL I, DIV 1, GP CD, CL II/III, DIV 1, GP EFG; CL I ZN 1 GP IIB Temperature class T*</p> <p>or</p> <p>CL I, DIV 1, GP CD, CL II/III, DIV 1, GP EFG; CL I ZN 1 GP IIB Associated Apparatus CL I/II/III DIV 1 GP ABCDEFG; CL I ZN 0 GP IIC Entity Temperature class T*</p>
INMETRO (BR)	<p>INMETRO approval: DEKRA 16.0012X</p> <p>Applied standards:</p> <ul style="list-style-type: none"> ▪ ABNT NBR IEC 60079-0 ▪ ABNT NBR IEC 60079-1 ▪ ABNT NBR IEC 60079-7 ▪ ABNT NBR IEC 60079-11 ▪ ABNT NBR IEC 60079-31 <p>Remote transmitter (depending on the model code): Ex db [ia Ga] IIC T6 Gb or Ex db eb [ia Ga] IIC T6 Gb or Ex db [ia Ga] IIB T6 Gb or Ex db eb [ia Ga] IIB T6 Gb Ex db [ia Ga] [ia IIC Ga] IIB T6 Gb or Ex db eb [ia Ga] [ia IIC Ga] IIB T6 Gb or Ex tb [ia Da] IIIC T75 °C Db</p> <p>Remote sensor (depending on the model code): Ex ib IIC T6...T1 Gb or Ex ib IIB T6...T1 Gb Ex ib IIIC T200 °C Db</p> <p>Integral type (depending on the model code): Ex db ib IIC T6...T1 Gb or Ex db eb ib IIC T6...T1 Gb or Ex db ib IIB T6...T1 Gb or Ex db eb ib IIB T6...T1 Gb or Ex db ib [ia Ga] IIC T6...T1 Gb or Ex db eb ib [ia Ga] IIC T6...T1 Gb or Ex db ib [ia IIC Ga] IIB T6...T1 Gb or Ex db eb ib [ia IIC Ga] IIB T6...T1 Gb Ex ib tb IIIC T150 °C Db or Ex ib tb [ia Da] IIIC T150 °C Db</p>

Type	Approval or certification
NEPSI (CN)	<p>Applied standards:</p> <ul style="list-style-type: none"> ▪ GB3836.1 ▪ GB3836.2 ▪ GB3836.3 ▪ GB3836.4 ▪ GB3836.19 ▪ GB3836.20
	<p>Remote transmitter (depending on the model code):</p> <p>Ex db [ia Ga] IIC T6 Gb or Ex db e [ia Ga] IIC T6 Gb or Ex db [ia Ga] IIB T6 Gb or Ex db e [ia Ga] IIB T6 Gb Ex db [ia Ga] [ia IIC Ga] IIB T6 Gb or Ex db e [ia Ga] [ia IIC Ga] IIB T6 Gb or Ex [iaD 20] tD A21 IP6X T75°C</p>
	<p>Remote sensor (depending on the model code):</p> <p>Ex ib IIC T6...T1 Gb or Ex ib IIB T6...T1 Gb Ex ibD 21 IP6X T200 °C</p>
	<p>Integral type (depending on the model code):</p> <p>Ex db ib IIC T6...T1 Gb or Ex db e ib IIC T6...T1 Gb or Ex db ib IIB T6...T1 Gb or Ex db e ib IIB T6...T1 Gb or Ex db ib [ia Ga] IIC T6...T1 Gb or Ex db e ib [ia Ga] IIC T6...T1 Gb or Ex db ib [ia IIC Ga] IIB T6...T1 Gb or Ex db e ib [ia IIC Ga] IIB T6...T1 Gb Ex ibD 21 tD A21 IP6X T150°C or Ex [iaD 20] ibD 21 tD A21 IP6X T150°C</p>

Type	Approval or certification
PESO (IN)	<p>PESO approval: PESO approval is based on ATEX certification by DEKRA Certificate Number: DEKRA 15ATEX0023 X</p> <p>PESO approval is only valid for type of protection “d” flameproof enclosure. Option Q11 must be ordered for conformity of device with PESO requirements.</p> <p>Equipment Reference Numbers: P434956/_ P434884/_ P434885/_ P431901/_ P431875/_ P432033/_ P434983/_ P434957/_ P434887/_</p> <p>Applied standards:</p> <ul style="list-style-type: none"> ▪ EN 60079-0 +A11 ▪ EN 60079-1 ▪ EN 60079-11
	<p>Remote transmitter (depending on the model code): Ex db [ia Ga] IIC T6 Gb or Ex db [ia Ga] IIB T6 Gb or Ex db [ia Ga] [ia IIC Ga] IIB T6 Gb</p>
	<p>Remote sensor (depending on the model code): Ex ib IIC T6...T1 Gb or Ex ib IIB T6...T1 Gb</p>
	<p>Integral type (depending on the model code): Ex db ib IIC T6...T1 Gb or Ex db ib IIB T6...T1 Gb or Ex db ib [ia Ga] IIC T6...T1 Gb or Ex db ib [ia IIC Ga] IIB T6...T1 Gb</p>
	<p>Please refer to IECEx approval for specifications. A device with IECEx approval (model code position 11, value: SF2_) must be ordered to comply with Safety Label requirements. For export to Taiwan and to get the Safety Label the Yokogawa representative in Taiwan must be contacted in advance.</p> <p>Identification Number: TD04000C</p>
Safety Label (TW)	

Type	Approval or certification
Korea Ex	<p>Korea Ex certificates:</p> <ul style="list-style-type: none"> ▪ 18-KA4BO-0507X ▪ 18-KA4BO-0508X ▪ 18-KA4BO-0513X ▪ 18-KA4BO-0526X ▪ 18-KA4BO-0509X ▪ 18-KA4BO-0510X ▪ 18-KA4BO-0539X ▪ 18-KA4BO-0540X ▪ 18-KA4BO-0541X ▪ 18-KA4BO-0681X ▪ 18-KA4BO-0542X ▪ 18-KA4BO-0682X ▪ 18-KA4BO-0529X ▪ 18-KA4BO-0530X <p>Applied standards:</p> <p>Notice of Ministry of Labor No 2016-54 harmonized with</p> <ul style="list-style-type: none"> ▪ IEC 60079-0 ▪ IEC 60079-1 ▪ IEC 60079-7 ▪ IEC 60079-11 ▪ IEC 60079-31
	<p>Remote transmitter (depending on the model code):</p> <p>Ex d [ia] IIC T6 Ex d e [ia] IIC T6 Ex d [ia] IIB T6 Ex d e [ia] IIB T6 Ex d [ia] [ia IIC] IIB T6 Ex d e [ia] [ia IIC] IIB T6 Ex tb [ia] IIIC T75 °C</p>
	<p>Remote sensor (depending on the model code):</p> <p>Ex ib IIB T6...T1 Ex ib IIC T6...T1 Ex ib IIIC T200 °C</p>
	<p>Integral type (depending on the model code):</p> <p>Ex d ib IIC T6...T1 or Ex d e ib IIC T6...T1 or Ex d ib [ia] IIC T6...T1 or Ex d e ib [ia] IIC T6...T1 or Ex d ib IIB T6...T1 or Ex d e ib IIB T6...T1 Ex d ib [ia IIC] IIB T6...T1 or Ex d e ib [ia IIC] IIB T6...T1 or Ex ib tb IIIC T150 °C or Ex ib tb [ia] IIIC T150 °C</p>

Type	Approval or certification
EAC Ex	Certificate Number: RU C-DE.AA71.B.00517 Applied standards: <ul style="list-style-type: none"> ▪ Gost 31610.0 (IEC 60079-0) ▪ Gost IEC 60079-1 ▪ Gost 31610.7 (IEC 60079-7) ▪ Gost 31610.11 (IEC 60079-11) ▪ Gost IEC 60079-31 ▪ Gost IEC 60079-14
	Remote transmitter (depending on the model code): 1Ex db [ia Ga] IIC T6 Gb X or 1Ex db e [ia Ga] IIC T6 Gb X or 1Ex db [ia Ga] IIB T6 Gb X or 1Ex db e [ia Ga] IIB T6 Gb X 1Ex db [ia Ga] [ia IIC Ga] IIB T6 Gb X or 1Ex db e [ia Ga] [ia IIC Ga] IIB T6 Gb X or 1Ex tb [ia Da] IIIC T75 °C Db X
	Remote sensor (depending on the model code): 1Ex ib IIC T6...T1 Gb X or 1Ex ib IIB T6...T1 Gb X 1Ex ib IIIC T200 °C Db X
	Integral type (depending on the model code): 1Ex db ib IIC T6...T1 Gb X or 1Ex db e ib IIC T6...T1 Gb X or 1Ex db ib IIB T6...T1 Gb X or 1Ex db e ib IIB T6...T1 Gb X or 1Ex db ib [ia Ga] IIC T6...T1 Gb X or 1Ex db e ib [ia Ga] IIC T6...T1 Gb X or 1Ex db ib [ia IIC Ga] IIB T6...T1 Gb X or 1Ex db e ib [ia IIC Ga] IIB T6...T1 Gb X 1Ex ib tb IIIC T150 °C Db X or 1Ex ib tb [ia Da] IIIC T150 °C Db X

Type	Approval or certification
Japan Ex	Japan Ex certificates: <ul style="list-style-type: none"> ▪ DEK 18.0053 X ▪ DEK 18.0054 X ▪ DEK 18.0055 X ▪ DEK 18.0056 X ▪ DEK 18.0057 X ▪ DEK 18.0060 X ▪ DEK 18.0061 X ▪ DEK 18.0062 X ▪ DEK 18.0063 X ▪ DEK 18.0064 X ▪ DEK 18.0069 X ▪ DEK 18.0070 X ▪ DEK 18.0071 X ▪ DEK 18.0072 X ▪ DEK 18.0073 X ▪ DEK 18.0078 X ▪ DEK 18.0079 X ▪ DEK 18.0080 X ▪ DEK 18.0081 X ▪ DEK 18.0082 X ▪ DEK 18.0087 X
	Applied standards: <ul style="list-style-type: none"> ▪ JNIOH-TR-46-1 : 2015 ▪ JNIOH-TR-46-2 : 2018 ▪ JNIOH-TR-46-6 : 2015
	Remote transmitter (depending on the model code): Ex db [ia Ga] IIC T6 Gb
	Remote sensor (depending on the model code): Ex ib IIC T4...T3 Gb
	Integral type (depending on the model code): Ex db ib IIC T4...T3 Gb
	Ingress protection
EMC	EU directive 2014/30/EU per EN 61326-1 Class A Table 2 and EN 61326-2-3
	NAMUR NE21
	RCM in Australia/New Zealand
	KC mark in Korea
	TR CU 020 in EAEU area
LVD	EU directive 2014/35/EU per: <ul style="list-style-type: none"> ▪ EN 61010-1 ▪ EN 61010-2-030
	TR CU 004 in EAEU area
PED	EU directive 2014/68/EU per AD 2000 Code
	TR CU 032 in EAEU area
Marine	DNV GL Type approval according to DNVGL-CP-0338 for options MC2 and MC3
RoHS	EU directive 2011/65/EU per EN 50581

Type	Approval or certification
SIL	Exida Certificate per IEC61508:2010 Parts 1-7 SIL 2 @ HFT=0; SIL 3 @ HFT =1
WEEE	EU directive 2012/19/EU (Waste Electrical and Electronic Equipment) is only valid in the European Economic Area. This instrument is intended to be sold and used only as a part of equipment which is excluded from the WEEE directive, such as large-scale stationary industrial tools, a large-scale fixed installation etc., and therefore it is in principle fully compliant with WEEE directive. The instrument should be disposed of in accordance with applicable national legislations or regulations, respectively.
NAMUR	NAMUR NE95 compliant
Metrological Regulations	Rotamass Total Insight is registered as a measuring instrument in the following countries: <ul style="list-style-type: none"> ▪ China ▪ Russia ▪ Belarus Please contact your Yokogawa representative regarding respective "Pattern Approval Certificate of Measuring Instruments" and for export to these countries.
IGC	Intergranular Corrosion testing according to EN ISO 3651-2 and ASTM for option P6
Sanitary Approvals	3-A Sanitary standards in combination with process connection types HS2, HS4, HS8 and HS9 EHEDG in combination with process connection type HS2, HS4, HS8 and HS9

10 Ordering information

10.1 Overview model code Hygienic 25

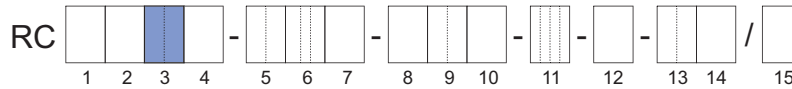

Model code position	1.	2.	3.	4.	5.	6.	7.	8.	9.	10.	11.	12.	13.	14.	Description	Restrictions
Transmitter	E														Essential (base function)	not with accuracy C7, C3, C2, 50 not with communication type and I/O JH, JJ, JK, JL, JM, JN, M2, M7, G_ not with option CST, AC_, CGC, BT, VM
	U														Ultimate (high function)	not with accuracy 70 not with display 0
	N														Spare sensor without transmitter, combinable with Rotamass TI transmitter	see restrictions below
Sensor	H														Hygienic	-
Meter size	25														Nominal mass flow : 1.6 t/h (59 lb/min) Maximum mass flow: 2.3 t/h (85 lb/min)	-
Material wetted parts	S														Stainless steel 1.4404/316L	-
Process connection size	25														DN25, 1"	-
	40														DN40, 1½"	
Process connection type	HS2														Threaded connection according to DIN 11851	see tables on page [45]
	HS4														Clamp process connection according to DIN 32676 series A	
	HS8														Clamp process connection according to DIN 32676 series C (Tri-Clamp)	see table on page [46]
	HS9														Clamp process connection according to JIS G3447 / ISO 2852	not with Ex approval FF_ see table on page [46]
Sensor housing material	0														Stainless steel 1.4301/304, 1.4404/316L	-
Process fluid temperature range	0														Standard, integral type: -50 – 140 °C (-58 – 284 °F), remote type: -70 – 140 °C (-94 – 284 °F)	-
Mass flow and density accuracy	E7														Liquid: 0.2 % mass flow deviation D_{flat} , 4 g/l maximum density deviation	not with transmitter N
	D7														Liquid: 0.15 % maximum mass flow deviation D_{flat} , 4 g/l maximum density deviation	
	C7														Liquid: 0.1 % mass flow deviation D_{flat} , 4 g/l maximum density deviation	not with transmitter E
	C3														Liquid: 0.1 % mass flow deviation D_{flat} , 1 g/l maximum density deviation	only with transmitter U
	C2														Liquid: 0.1 % mass flow deviation D_{flat} , 0.5 g/l maximum density deviation	not with transmitter E
	70														Gas: 0.75 % mass flow deviation D_{flat}	only with transmitter E
	50														Gas: 0.5 % mass flow deviation D_{flat}	not with transmitter E not with option CST, AC_, VM
Design and housing	0														Integral type with "urethane-cured polyester powder coating" coated aluminum transmitter housing	not with communication type and I/O NN
	2														Integral type with "corrosion protection coating" coated aluminum transmitter housing	not with option L_..., MC_, Y_...
	A														Remote type with "urethane-cured polyester powder coating" coated aluminum transmitter housing and standard neck sensor	not with option RB
	E														Remote type with "corrosion protection coating" coated aluminum transmitter housing and standard neck sensor	
	J														Remote type stainless steel transmitter and standard neck sensor	not with Ex approval KF21, SF21, GF21, UF21, NF21, PF21, JF5_ not with option RB, SA

Model code position	1.	2.	3.	4.	5.	6.	7.	8.	9.	10.	11.	12.	13.	14.	Description	Restrictions
Ex approval											NN00				None	not with communication type and I/O JP, JQ, JR, JS, G1 not with option EPT
											KF21				ATEX, explosion group IIC and IIIC	not with design and housing J
											KF22				ATEX, explosion group IIB and IIIC	–
											SF21				IECEX, explosion group IIC and IIIC	not with design and housing J
											SF22				IECEX, explosion group IIB and IIIC	
											GF21				EAC Ex, explosion group IIC and IIIC	not with design and housing J only with option VB, VE or VR
											GF22				EAC Ex, explosion group IIB and IIIC	only with option VB, VE or VR
											FF11				FM, groups A, B, C, D, E, F, G	not with transmitter N, cable entries 4, communication type and I/O G_ not with option KC, VB, VE, VR, Y_...
											FF12				FM, groups C, D, E, F, G	not with process connection type HS9
											UF21				INMETRO, explosion group IIC and IIIC	not with design and housing J
											UF22				INMETRO, explosion group IIB and IIIC	
											NF21				NEPSI, explosion group IIC and IIIC	not with design and housing J only with option CN
											NF22				NEPSI, explosion group IIB and IIIC	only with option CN
											PF21				Korea Ex, explosion group IIC and IIIC	not with design and housing J only with option KC
											PF22				Korea Ex, explosion group IIB and for integral type also IIIC	only with option KC
											JF53				Japan Ex, Temperature class T3, explosion group IIC	not with transmitter N, design and housing J, cable entries 2, communication type and I/O JP, JQ, JR, JS, G1, display 0
											JF54				Japan Ex, Temperature class T4, explosion group IIC	only with option PJ and V52 or V53 not with option EPT, Y_...
	Cable entries												2		ANSI ½" NPT	not with Ex approval JF5_
												4		ISO M20x1.5	not with Ex approval FF11, FF12	

Model code position	1.	2.	3.	4.	5.	6.	7.	8.	9.	10.	11.	12.	13.	14.	Description	Restrictions	
Communication type and I/O													JA		1 active current output HART, 1 passive pulse or status output	not with option CGC, VM	
													JB		2 active current outputs one with HART, 2 passive pulse or status outputs		
													JC		2 active current outputs one with HART, 1 passive pulse or status output, 1 voltage-free status input		
													JD		1 active current output HART, 2 passive pulse or status outputs, 1 passive status output		
													JE		1 active current output HART, 2 passive pulse or status outputs, 1 voltage-free status input		
													JF		1 active current output HART, 1 passive pulse or status output, 1 active pulse or status output with pull-up resistor, 1 voltage-free status input		
													JG		1 active current output HART, 1 passive pulse or status output, 1 active pulse or status output, 1 voltage-free status input		
														JH		1 active current output HART, 1 passive pulse or status output, 1 passive current output, 1 active current input	not with transmitter E
														JJ		1 active current output HART, 2 passive pulse or status outputs, 1 active current input	
														JK		1 active current output HART, 1 passive pulse or status output, 1 voltage-free status input, 1 active current input	
														JL		1 active current output HART, 1 passive pulse or status output, 1 passive current output, 1 passive current input	
														JM		1 active current output HART, 2 passive pulse or status outputs, 1 passive current input	
														JN		1 active current output HART, 1 passive pulse or status output, 1 voltage-free status input, 1 passive current input	

Model code position	1.	2.	3.	4.	5.	6.	7.	8.	9.	10.	11.	12.	13.	14.	Description	Restrictions
Communication type and I/O													JP		2 passive current outputs one with HART, 1 passive pulse or status output	
													JQ		2 passive current outputs one with HART, 2 passive pulse or status outputs	not with Ex approval NN00, JF5_
													JR		2 passive current outputs one with HART, 1 passive NAMUR pulse or status output	not with option CGC, MC_, VM
													JS		2 passive current outputs one with HART, 2 passive NAMUR pulse or status outputs	
													M0		Modbus output, 1 passive pulse or status output	not with option CGC, PS, BT, VM
													M2		Modbus output, 1 passive pulse or status output, 1 active current input	not with transmitter E not with option PS, BT, VM
													M3		Modbus output, 2 passive pulse or status outputs	
													M4		Modbus output, 1 passive pulse or status output, 1 active pulse or status output	
													M5		Modbus output, 1 passive pulse or status output, 1 active pulse or status output with pull-up resistor	not with option CGC, PS, BT, VM
													M6		Modbus output, 1 passive pulse or status output, 1 active current output	
													M7		Modbus output, 1 passive pulse or status output, 1 passive current input	not with transmitter E not with option PS, BT, VM
													G0		PROFIBUS PA, 1 passive pulse output	not with transmitter E not with Ex Approval FF11, FF12 not with option PS, BT, MC_
													G1		PROFIBUS PA, intrinsically safe, 1 passive pulse output	not with transmitter E not with Ex Approval NN00, FF11, FF12, JF5_ not with option PS, Q11, BT, MC_
												NN		Spare sensor without transmitter, all communication types and I/Os apply	only with transmitter N not with design and housing 0, 2, Ex Approval FF11, FF12, JF5_ not with option VB, VR	
Display													0	No display	only with transmitter E not with option JF5_	
													1	With display	not with transmitter N	
													N	Spare sensor without transmitter, no display applied	only with transmitter N not with Ex Approval FF11, FF12, JF5_ not with option VB, VR	

10.2 Overview model code Hygienic 40

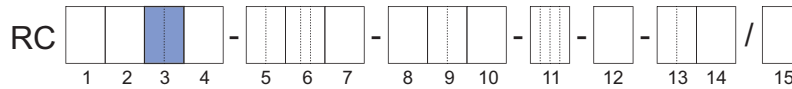

Model code position	1.	2.	3.	4.	5.	6.	7.	8.	9.	10.	11.	12.	13.	14.	Description	Restrictions
Transmitter	E														Essential (base function)	not with accuracy C7, C3, C2, 50 not with communication type and I/O JH, JJ, JK, JL, JM, JN, M2, M7, G_ not with option CST, AC_, CGC, BT, VM
	U														Ultimate (high function)	not with accuracy 70 not with display 0
	N														Spare sensor without transmitter, combinable with Rotamass TI transmitter	see restrictions below
Sensor	H														Hygienic	–
Meter size	40														Nominal mass flow : 4.7 t/h (170 lb/min) Maximum mass flow: 7 t/h (260 lb/min)	–
Material wetted parts	S														Stainless steel 1.4404/316L	–
Process connection size	25														DN25, 1"	–
	40														DN40, 1½"	
Process connection type	HS2														Threaded connection according to DIN 11851	see tables on page [45]
	HS4														Clamp process connection according to DIN 32676 series A	
	HS8														Clamp process connection according to DIN 32676 series C (Tri-Clamp)	see table on page [46]
	HS9														Clamp process connection according to JIS G3447 / ISO 2852	not with Ex approval FF_ see table on page [46]
Sensor housing material	0														Stainless steel 1.4301/304, 1.4404/316L	–
Process fluid temperature range	0														Standard, integral type: -50 – 140 °C (-58 – 284 °F), remote type: -70 – 140 °C (-94 – 284 °F)	–
Mass flow and density accuracy	E7														Liquid: 0.2 % mass flow deviation D_{flat} , 4 g/l maximum density deviation	not with transmitter N
	D7														Liquid: 0.15 % maximum mass flow deviation D_{flat} , 4 g/l maximum density deviation	
	C7														Liquid: 0.1 % mass flow deviation D_{flat} , 4 g/l maximum density deviation	not with transmitter E
	C3														Liquid: 0.1 % mass flow deviation D_{flat} , 1 g/l maximum density deviation	only with transmitter U
	C2														Liquid: 0.1 % mass flow deviation D_{flat} , 0.5 g/l maximum density deviation	not with transmitter E
	70														Gas: 0.75 % mass flow deviation D_{flat}	only with transmitter E
	50														Gas: 0.5 % mass flow deviation D_{flat}	not with transmitter E not with option CST, AC_, VM
Design and housing	0														Integral type with "urethane-cured polyester powder coating" coated aluminum transmitter housing	not with communication type and I/O NN
	2														Integral type with "corrosion protection coating" coated aluminum transmitter housing	not with option L_..., MC_, Y_...
	A														Remote type with "urethane-cured polyester powder coating" coated aluminum transmitter housing and standard neck sensor	not with option RB
	E														Remote type with "corrosion protection coating" coated aluminum transmitter housing and standard neck sensor	
	J														Remote type stainless steel transmitter and standard neck sensor	not with Ex approval KF21, SF21, GF21, UF21, NF21, PF21, JF5_ not with option RB, SA

Model code position	1.	2.	3.	4.	5.	6.	7.	8.	9.	10.	11.	12.	13.	14.	Description	Restrictions
Ex approval											NN00				None	not with communication type and I/O JP, JQ, JR, JS, G1 not with option EPT
											KF21				ATEX, explosion group IIC and IIIC	not with design and housing J
											KF22				ATEX, explosion group IIB and IIIC	–
											SF21				IECEX, explosion group IIC and IIIC	not with design and housing J
											SF22				IECEX, explosion group IIB and IIIC	
											GF21				EAC Ex, explosion group IIC and IIIC	not with design and housing J only with option VB, VE or VR
											GF22				EAC Ex, explosion group IIB and IIIC	only with option VB, VE or VR
											FF11				FM, groups A, B, C, D, E, F, G	not with transmitter N, cable entries 4, communication type and I/O G_ not with option KC, VB, VE, VR, Y_...
											FF12				FM, groups C, D, E, F, G	not with process connection type HS9
											UF21				INMETRO, explosion group IIC and IIIC	not with design and housing J
											UF22				INMETRO, explosion group IIB and IIIC	
											NF21				NEPSI, explosion group IIC and IIIC	not with design and housing J only with option CN
											NF22				NEPSI, explosion group IIB and IIIC	only with option CN
											PF21				Korea Ex, explosion group IIC and IIIC	not with design and housing J only with option KC
											PF22				Korea Ex, explosion group IIB and for integral type also IIIC	only with option KC
											JF53				Japan Ex, Temperature class T3, explosion group IIC	not with transmitter N, design and housing J, cable entries 2, communication type and I/O JP, JQ, JR, JS, G1, display 0
											JF54				Japan Ex, Temperature class T4, explosion group IIC	only with option PJ and V52 or V53 not with option EPT, Y_...
Cable entries												2		ANSI ½" NPT	not with Ex approval JF5_	
												4		ISO M20x1.5	not with Ex approval FF11, FF12	

Model code position	1.	2.	3.	4.	5.	6.	7.	8.	9.	10.	11.	12.	13.	14.	Description	Restrictions	
Communication type and I/O													JA		1 active current output HART, 1 passive pulse or status output	not with option CGC, VM	
													JB		2 active current outputs one with HART, 2 passive pulse or status outputs		
													JC		2 active current outputs one with HART, 1 passive pulse or status output, 1 voltage-free status input		
													JD		1 active current output HART, 2 passive pulse or status outputs, 1 passive status output		
													JE		1 active current output HART, 2 passive pulse or status outputs, 1 voltage-free status input		
													JF		1 active current output HART, 1 passive pulse or status output, 1 active pulse or status output with pull-up resistor, 1 voltage-free status input		
													JG		1 active current output HART, 1 passive pulse or status output, 1 active pulse or status output, 1 voltage-free status input		
														JH		1 active current output HART, 1 passive pulse or status output, 1 passive current output, 1 active current input	not with transmitter E
														JJ		1 active current output HART, 2 passive pulse or status outputs, 1 active current input	
														JK		1 active current output HART, 1 passive pulse or status output, 1 voltage-free status input, 1 active current input	
														JL		1 active current output HART, 1 passive pulse or status output, 1 passive current output, 1 passive current input	
														JM		1 active current output HART, 2 passive pulse or status outputs, 1 passive current input	
														JN		1 active current output HART, 1 passive pulse or status output, 1 voltage-free status input, 1 passive current input	

Model code position	1.	2.	3.	4.	5.	6.	7.	8.	9.	10.	11.	12.	13.	14.	Description	Restrictions
Communication type and I/O													JP		2 passive current outputs one with HART, 1 passive pulse or status output	
													JQ		2 passive current outputs one with HART, 2 passive pulse or status outputs	not with Ex approval NN00, JF5_
													JR		2 passive current outputs one with HART, 1 passive NAMUR pulse or status output	not with option CGC, MC_, VM
													JS		2 passive current outputs one with HART, 2 passive NAMUR pulse or status outputs	
													M0		Modbus output, 1 passive pulse or status output	not with option CGC, PS, BT, VM
													M2		Modbus output, 1 passive pulse or status output, 1 active current input	not with transmitter E not with option PS, BT, VM
													M3		Modbus output, 2 passive pulse or status outputs	
													M4		Modbus output, 1 passive pulse or status output, 1 active pulse or status output	not with option CGC, PS, BT, VM
													M5		Modbus output, 1 passive pulse or status output, 1 active pulse or status output with pull-up resistor	
													M6		Modbus output, 1 passive pulse or status output, 1 active current output	
													M7		Modbus output, 1 passive pulse or status output, 1 passive current input	not with transmitter E not with option PS, BT, VM
													G0		PROFIBUS PA, 1 passive pulse output	not with transmitter E not with Ex Approval FF11, FF12 not with option PS, BT, MC_
													G1		PROFIBUS PA, intrinsically safe, 1 passive pulse output	not with transmitter E not with Ex Approval NN00, FF11, FF12, JF5_ not with option PS, Q11, BT, MC_
												NN		Spare sensor without transmitter, all communication types and I/Os apply	only with transmitter N not with design and housing 0, 2, Ex Approval FF11, FF12, JF5_ not with option VB, VR	
Display													0	No display	only with transmitter E not with option JF5_	
													1	With display	not with transmitter N	
													N	Spare sensor without transmitter, no display applied	only with transmitter N not with Ex Approval FF11, FF12, JF5_ not with option VB, VR	

10.3 Overview model code Hygienic 50

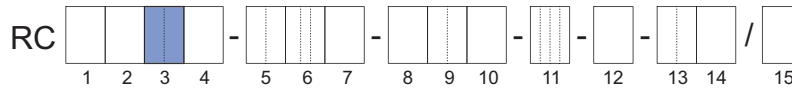

Model code position	1.	2.	3.	4.	5.	6.	7.	8.	9.	10.	11.	12.	13.	14.	Description	Restrictions
Transmitter	E														Essential (base function)	not with accuracy C7, C3, C2, 50 not with communication type and I/O JH, JJ, JK, JL, JM, JN, M2, M7, G_ not with option CST, AC_, CGC, BT, VM
	U														Ultimate (high function)	not with accuracy 70 not with display 0
	N														Spare sensor without transmitter, combinable with Rotamass TI transmitter	see restrictions below
Sensor	H														Hygienic	-
Meter size	50														Nominal mass flow : 20 t/h (730 lb/min) Maximum mass flow: 29 t/h (1100 lb/min)	-
Material wetted parts	S														Stainless steel 1.4404/316L	-
Process connection size	40														DN40, 1½"	-
	50														DN50, 2"	-
Process connection type	HS2														Threaded connection according to DIN 11851	see tables on page [45]
	HS4														Clamp process connection according to DIN 32676 series A	
	HS8														Clamp process connection according to DIN 32676 series C (Tri-Clamp)	see table on page [46]
	HS9														Clamp process connection according to JIS G3447 / ISO 2852	not with Ex approval FF_ see table on page [46]
Sensor housing material	0														Stainless steel 1.4301/304, 1.4404/316L	-
Process fluid temperature range	0														Standard, integral type: -50 – 140 °C (-58 – 284 °F), remote type: -70 – 140 °C (-94 – 284 °F)	-
Mass flow and density accuracy	E7														Liquid: 0.2 % mass flow deviation D_{flat} , 4 g/l maximum density deviation	not with transmitter N
	D7														Liquid: 0.15 % maximum mass flow deviation D_{flat} , 4 g/l maximum density deviation	
	C7														Liquid: 0.1 % mass flow deviation D_{flat} , 4 g/l maximum density deviation	not with transmitter E
	C3														Liquid: 0.1 % mass flow deviation D_{flat} , 1 g/l maximum density deviation	only with transmitter U
	C2														Liquid: 0.1 % mass flow deviation D_{flat} , 0.5 g/l maximum density deviation	not with transmitter E
	70														Gas: 0.75 % mass flow deviation D_{flat}	only with transmitter E
	50														Gas: 0.5 % mass flow deviation D_{flat}	not with transmitter E not with option CST, AC_, VM
Design and housing	0														Integral type with "urethane-cured polyester powder coating" coated aluminum transmitter housing	not with communication type and I/O NN
	2														Integral type with "corrosion protection coating" coated aluminum transmitter housing	not with option L_..., MC_, Y_...
	A														Remote type with "urethane-cured polyester powder coating" coated aluminum transmitter housing and standard neck sensor	not with option RB
	E														Remote type with "corrosion protection coating" coated aluminum transmitter housing and standard neck sensor	
	J														Remote type stainless steel transmitter and standard neck sensor	not with Ex approval KF21, SF21, GF21, UF21, NF21, PF21, JF5_ not with option RB, SA

Model code position	1.	2.	3.	4.	5.	6.	7.	8.	9.	10.	11.	12.	13.	14.	Description	Restrictions	
Ex approval											11.				NN00	None	not with communication type and I/O JP, JQ, JR, JS, G1 not with option EPT
															KF21	ATEX, explosion group IIC and IIIC	not with design and housing J
															KF22	ATEX, explosion group IIB and IIIC	–
															SF21	IECEX, explosion group IIC and IIIC	not with design and housing J
															SF22	IECEX, explosion group IIB and IIIC	
															GF21	EAC Ex, explosion group IIC and IIIC	not with design and housing J only with option VB, VE or VR
															GF22	EAC Ex, explosion group IIB and IIIC	only with option VB, VE or VR
															FF11	FM, groups A, B, C, D, E, F, G	not with transmitter N, cable entries 4, communication type and I/O G_ not with option KC, VB, VE, VR, Y_...
															FF12	FM, groups C, D, E, F, G	not with process connection type HS9
															UF21	INMETRO, explosion group IIC and IIIC	not with design and housing J
															UF22	INMETRO, explosion group IIB and IIIC	
															NF21	NEPSI, explosion group IIC and IIIC	not with design and housing J only with option CN
															NF22	NEPSI, explosion group IIB and IIIC	only with option CN
															PF21	Korea Ex, explosion group IIC and IIIC	not with design and housing J only with option KC
															PF22	Korea Ex, explosion group IIB and for integral type also IIIC	only with option KC
															JF53	Japan Ex, Temperature class T3, explosion group IIC	not with transmitter N, design and housing J, cable entries 2, communication type and I/O JP, JQ, JR, JS, G1, display 0
															JF54	Japan Ex, Temperature class T4, explosion group IIC	only with option PJ and V52 or V53 not with option EPT, Y_...
Cable entries													2		ANSI ½" NPT	not with Ex approval JF5_	
													4		ISO M20x1.5	not with Ex approval FF11, FF12	

Model code position	1.	2.	3.	4.	5.	6.	7.	8.	9.	10.	11.	12.	13.	14.	Description	Restrictions	
Communication type and I/O													JA		1 active current output HART, 1 passive pulse or status output	not with option CGC, VM	
													JB		2 active current outputs one with HART, 2 passive pulse or status outputs		
													JC		2 active current outputs one with HART, 1 passive pulse or status output, 1 voltage-free status input		
													JD		1 active current output HART, 2 passive pulse or status outputs, 1 passive status output		
													JE		1 active current output HART, 2 passive pulse or status outputs, 1 voltage-free status input		
													JF		1 active current output HART, 1 passive pulse or status output, 1 active pulse or status output with pull-up resistor, 1 voltage-free status input		
													JG		1 active current output HART, 1 passive pulse or status output, 1 active pulse or status output, 1 voltage-free status input		
														JH		1 active current output HART, 1 passive pulse or status output, 1 passive current output, 1 active current input	not with transmitter E
														JJ		1 active current output HART, 2 passive pulse or status outputs, 1 active current input	
														JK		1 active current output HART, 1 passive pulse or status output, 1 voltage-free status input, 1 active current input	
														JL		1 active current output HART, 1 passive pulse or status output, 1 passive current output, 1 passive current input	
														JM		1 active current output HART, 2 passive pulse or status outputs, 1 passive current input	
														JN		1 active current output HART, 1 passive pulse or status output, 1 voltage-free status input, 1 passive current input	

Model code position	1.	2.	3.	4.	5.	6.	7.	8.	9.	10.	11.	12.	13.	14.	Description	Restrictions
Communication type and I/O													JP		2 passive current outputs one with HART, 1 passive pulse or status output	
													JQ		2 passive current outputs one with HART, 2 passive pulse or status outputs	not with Ex approval NN00, JF5_
													JR		2 passive current outputs one with HART, 1 passive NAMUR pulse or status output	not with option CGC, MC_, VM
													JS		2 passive current outputs one with HART, 2 passive NAMUR pulse or status outputs	
													M0		Modbus output, 1 passive pulse or status output	not with option CGC, PS, BT, VM
													M2		Modbus output, 1 passive pulse or status output, 1 active current input	not with transmitter E not with option PS, BT, VM
													M3		Modbus output, 2 passive pulse or status outputs	
													M4		Modbus output, 1 passive pulse or status output, 1 active pulse or status output	not with option CGC, PS, BT, VM
													M5		Modbus output, 1 passive pulse or status output, 1 active pulse or status output with pull-up resistor	
													M6		Modbus output, 1 passive pulse or status output, 1 active current output	
													M7		Modbus output, 1 passive pulse or status output, 1 passive current input	not with transmitter E not with option PS, BT, VM
													G0		PROFIBUS PA, 1 passive pulse output	not with transmitter E not with Ex Approval FF11, FF12 not with option PS, BT, MC_
													G1		PROFIBUS PA, intrinsically safe, 1 passive pulse output	not with transmitter E not with Ex Approval NN00, FF11, FF12, JF5_ not with option PS, Q11, BT, MC_
												NN		Spare sensor without transmitter, all communication types and I/Os apply	only with transmitter N not with design and housing 0, 2, Ex Approval FF11, FF12, JF5_ not with option VB, VR	
Display													0	No display	only with transmitter E not with option JF5_	
													1	With display	not with transmitter N	
													N	Spare sensor without transmitter, no display applied	only with transmitter N not with Ex Approval FF11, FF12, JF5_ not with option VB, VR	

10.4 Overview model code Hygienic 80

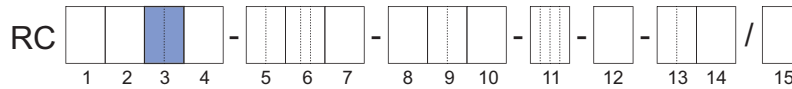

Model code position	1.	2.	3.	4.	5.	6.	7.	8.	9.	10.	11.	12.	13.	14.	Description	Restrictions
Transmitter	E														Essential (base function)	not with accuracy C7, C3, C2, 50 not with communication type and I/O JH, JJ, JK, JL, JM, JN, M2, M7, G_ not with option CST, AC_, CGC, BT, VM
	U														Ultimate (high function)	not with accuracy 70 not with display 0
	N														Spare sensor without transmitter, combinable with Rotamass TI transmitter	see restrictions below
Sensor	H														Hygienic	-
Meter size	80														Nominal mass flow : 51 t/h (1900 lb/min) Maximum mass flow: 76 t/h (2800 lb/min)	-
Material wetted parts	S														Stainless steel 1.4404/316L	-
Process connection size	50														DN50, 2"	-
	65														DN65, 2½"	
	80														DN80, 3"	
Process connection type	HS2														Threaded connection according to DIN 11851	see tables on page [45]
	HS4														Clamp process connection according to DIN 32676 series A	
	HS8														Clamp process connection according to DIN 32676 series C (Tri-Clamp)	see table on page [46]
	HS9														Clamp process connection according to JIS G3447 / ISO 2852	not with Ex approval FF_ see table on page [46]
Sensor housing material	0														Stainless steel 1.4301/304, 1.4404/316L	-
Process fluid temperature range	0														Standard, integral type: -50 – 140 °C (-58 – 284 °F), remote type: -70 – 140 °C (-94 – 284 °F)	-
Mass flow and density accuracy	E7														Liquid: 0.2 % mass flow deviation D_{flat} , 4 g/l maximum density deviation	not with transmitter N
	D7														Liquid: 0.15 % maximum mass flow deviation D_{flat} , 4 g/l maximum density deviation	
	C7														Liquid: 0.1 % mass flow deviation D_{flat} , 4 g/l maximum density deviation	not with transmitter E
	C3														Liquid: 0.1 % mass flow deviation D_{flat} , 1 g/l maximum density deviation	only with transmitter U
	C2														Liquid: 0.1 % mass flow deviation D_{flat} , 0.5 g/l maximum density deviation	not with transmitter E
	70														Gas: 0.75 % mass flow deviation D_{flat}	only with transmitter E
	50														Gas: 0.5 % mass flow deviation D_{flat}	not with transmitter E not with option CST, AC_, VM
Design and housing	0														Integral type with "urethane-cured polyester powder coating" coated aluminum transmitter housing	not with communication type and I/O NN
	2														Integral type with "corrosion protection coating" coated aluminum transmitter housing	not with option L_..., MC_, Y_...
	A														Remote type with "urethane-cured polyester powder coating" coated aluminum transmitter housing and standard neck sensor	not with option RB
	E														Remote type with "corrosion protection coating" coated aluminum transmitter housing and standard neck sensor	
	J														Remote type stainless steel transmitter and standard neck sensor	not with Ex approval KF21, SF21, GF21, UF21, NF21, PF21, JF5_ not with option RB, SA

Model code position	1.	2.	3.	4.	5.	6.	7.	8.	9.	10.	11.	12.	13.	14.	Description	Restrictions
Ex approval											NN00			None	not with communication type and I/O JP, JQ, JR, JS, G1 not with option EPT	
											KF21			ATEX, explosion group IIC and IIIC	not with design and housing J	
											KF22			ATEX, explosion group IIB and IIIC	–	
											SF21			IECEX, explosion group IIC and IIIC	not with design and housing J	
											SF22			IECEX, explosion group IIB and IIIC		
											GF21			EAC Ex, explosion group IIC and IIIC	not with design and housing J only with option VB, VE or VR	
											GF22			EAC Ex, explosion group IIB and IIIC	only with option VB, VE or VR	
											FF11			FM, groups A, B, C, D, E, F, G	not with transmitter N, cable entries 4, communication type and I/O G_	
											FF12			FM, groups C, D, E, F, G	not with option KC, VB, VE, VR, Y_... not with process connection type HS9	
											UF21			INMETRO, explosion group IIC and IIIC	not with design and housing J	
											UF22			INMETRO, explosion group IIB and IIIC		
											NF21			NEPSI, explosion group IIC and IIIC	not with design and housing J only with option CN	
											NF22			NEPSI, explosion group IIB and IIIC	only with option CN	
											PF21			Korea Ex, explosion group IIC and IIIC	not with design and housing J only with option KC	
											PF22			Korea Ex, explosion group IIB and for integral type also IIIC	only with option KC	
											JF53			Japan Ex, Temperature class T3, explosion group IIC	not with transmitter N, design and housing J, cable entries 2, communication type and I/O JP, JQ, JR, JS, G1, display 0	
											JF54			Japan Ex, Temperature class T4, explosion group IIC	only with option PJ and V52 or V53 not with option EPT, Y_..._	
Cable entries												2		ANSI ½" NPT	not with Ex approval JF5_	
												4		ISO M20x1.5	not with Ex approval FF11, FF12	

Model code position	1.	2.	3.	4.	5.	6.	7.	8.	9.	10.	11.	12.	13.	14.	Description	Restrictions	
Communication type and I/O													JA		1 active current output HART, 1 passive pulse or status output	not with option CGC, VM	
													JB		2 active current outputs one with HART, 2 passive pulse or status outputs		
													JC		2 active current outputs one with HART, 1 passive pulse or status output, 1 voltage-free status input		
													JD		1 active current output HART, 2 passive pulse or status outputs, 1 passive status output		
													JE		1 active current output HART, 2 passive pulse or status outputs, 1 voltage-free status input		
													JF		1 active current output HART, 1 passive pulse or status output, 1 active pulse or status output with pull-up resistor, 1 voltage-free status input		
													JG		1 active current output HART, 1 passive pulse or status output, 1 active pulse or status output, 1 voltage-free status input		
														JH		1 active current output HART, 1 passive pulse or status output, 1 passive current output, 1 active current input	not with transmitter E
														JJ		1 active current output HART, 2 passive pulse or status outputs, 1 active current input	
														JK		1 active current output HART, 1 passive pulse or status output, 1 voltage-free status input, 1 active current input	
														JL		1 active current output HART, 1 passive pulse or status output, 1 passive current output, 1 passive current input	
														JM		1 active current output HART, 2 passive pulse or status outputs, 1 passive current input	
														JN		1 active current output HART, 1 passive pulse or status output, 1 voltage-free status input, 1 passive current input	

Model code position	1.	2.	3.	4.	5.	6.	7.	8.	9.	10.	11.	12.	13.	14.	Description	Restrictions
Communication type and I/O													JP		2 passive current outputs one with HART, 1 passive pulse or status output	
													JQ		2 passive current outputs one with HART, 2 passive pulse or status outputs	not with Ex approval NN00, JF5_
													JR		2 passive current outputs one with HART, 1 passive NAMUR pulse or status output	not with option CGC, MC_, VM
													JS		2 passive current outputs one with HART, 2 passive NAMUR pulse or status outputs	
													M0		Modbus output, 1 passive pulse or status output	not with option CGC, PS, BT, VM
													M2		Modbus output, 1 passive pulse or status output, 1 active current input	not with transmitter E not with option PS, BT, VM
													M3		Modbus output, 2 passive pulse or status outputs	
													M4		Modbus output, 1 passive pulse or status output, 1 active pulse or status output	
													M5		Modbus output, 1 passive pulse or status output, 1 active pulse or status output with pull-up resistor	not with option CGC, PS, BT, VM
													M6		Modbus output, 1 passive pulse or status output, 1 active current output	
													M7		Modbus output, 1 passive pulse or status output, 1 passive current input	not with transmitter E not with option PS, BT, VM
														G0	PROFIBUS PA, 1 passive pulse output	not with transmitter E not with Ex Approval FF11, FF12 not with option PS, BT, MC_
														G1	PROFIBUS PA, intrinsically safe, 1 passive pulse output	not with transmitter E not with Ex Approval NN00, FF11, FF12, JF5_ not with option PS, Q11, BT, MC_
													NN	Spare sensor without transmitter, all communication types and I/Os apply	only with transmitter N not with design and housing 0, 2, Ex Approval FF11, FF12, JF5_ not with option VB, VR	
Display														0	No display	only with transmitter E not with option JF5_
														1	With display	not with transmitter N
														N	Spare sensor without transmitter, no display applied	only with transmitter N not with Ex Approval FF11, FF12, JF5_ not with option VB, VR

10.5 Overview options

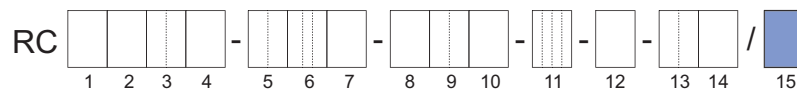

Option category	Options	Description	Restriction
Additional nameplate information	BG	Nameplate with customer device location identification	–
Presetting of customer parameters	PS	Presetting according to customer parameters	not with transmitter N, communication type and I/O G _– , M _–
Country-specific delivery	PJ	Delivery to Japan incl. SI units pre-setting and Quality Inspection Certificate (EN/JP)	–
	CN	Delivery to China including China RoHS mark	
	KC	Delivery to Korea including KC mark	not with Ex Approval FF1 _–
	VE	Delivery to EAEU area including EAC mark	
	VB	Delivery to EAEU area including EAC mark and Belarus Pattern Approval mark	not with transmitter N, Ex Approval FF1 _– , communication type and I/O G _–
	VR	Delivery to EAEU area including EAC mark and Russia Pattern Approval mark	not with Ex Approval FF1 _–
Country-specific application	Q11	PESO approval delivery	only with Ex Approval KF2 _– not with communication type and I/O G1
	QR	Primary calibration valid in Russia, including certificate	only with option VR not with transmitter N
Concentration and petroleum measurement	AC0	Advanced concentration measurement, customer settings	only with transmitter U not with mass flow and density accuracy 70, 50
	AC1	Advanced concentration measurement, one default data set	
	AC2	Advanced concentration measurement, two default data sets	
	AC3	Advanced concentration measurement, three default data sets	
	AC4	Advanced concentration measurement, four default data sets	
	CST	Standard concentration measurement	
Mass flow calibration	K2	Customer-specific 5-point mass flow calibration with measuring range on factory calibration certificate (mass flow or volume flow of water). A table listing the desired calibration points must be supplied with the order.	–
	K5	Customer-specific 10-point mass flow calibration with measuring range on DAkkS calibration certificate (mass flow or volume flow of water). A table listing the desired calibration points must be supplied with the order.	
Accordance with terms of order	P2	Declaration of compliance with the order 2.1 according to EN 10204	not with option P10, P11, P12, P13
	P3	Quality Inspection Certificate (Inspection Certificate 3.1 according to EN 10204)	

Option category	Options	Description	Restriction
Material certificates	P6	Certificate of Marking Transfer and Raw Material Certificates (Inspection Certificate 3.1 according to EN 10204), including IGC and conform to NACE MR0175 and MR0103	not with option P10, P11, P12, P13
Pressure testing	P8	Hydrostatic Pressure Test Certificate (Inspection Certificate 3.1 according to EN 10204)	not with option P10, P12, P13, P14
Surfaces free of oil and grease	H1	Degreasing of wetted surfaces according to ASTM G93-03 (Level C), including test report	–
Welding certificates	WP	WPS according to DIN EN ISO 15609-1	not with option P13, P14, P15, P16
		WPQR according to DIN EN ISO 15614-1	
		WQC according to DIN EN 287-1 or DIN EN ISO 6906-4	
Calibration certificate	L2	The certificate confirms that the delivered instrument has undergone a calibration traceable to national standards, including a list of working standards used for calibration. Language: English/Japanese	not with transmitter N
	L3	The certificate confirms that the delivered instrument has undergone a calibration traceable to national standards, including a list of primary standards to which the delivered product is traceable. Language: English/Japanese	
	L4	The certificate confirms that the delivered instrument has undergone a calibration traceable to national standards and that the calibration system of Rota Yokogawa is traceable to national standards. Language: English/Japanese	
X-ray inspection of flange weld seam	RT	X-ray inspection of flange weld seam according to DIN EN ISO 17636-1/B Evaluation according to AD2000HP 5/3 and DIN EN ISO 5817/C, including certificate	–
Positive Material Identification of wetted parts	PM	Positive Material Identification of wetted parts, including certificate (Inspection Certificate 3.1 according to EN 10204)	not with option P11, P13, P14
Tube Health Check	TC	Tube Health Check	not with transmitter N
Dye penetrant test of weld seams	PT	Dye penetrant test of process connection weld seams according to DIN EN ISO 3452-1, including certificate	not with option P12, P13
Transmitter housing rotated 180°	RB	Alignment of transmitter housing rotated 180°	not with transmitter N not with design and housing A, E, J
Enhanced process temperature (Ex)	EPT	Expanded process fluid temperature range for temperature classes T6, T5, T4 and T3 for hazardous areas	not with meter size 80 not with Ex approval NN00, JF5_
Measurement of heat quantity	CGC	Measurement of the total transported energy content of a fuel in connection with a sensor for determining the fuel's calorific value (e.g. a gas chromatograph, not included in scope of delivery)	only with transmitter U only with communication type and I/O JH, JJ, JK, JL, JM, JN, M2, M7, G_

Option category	Options	Description	Restriction
Connecting cable type and length	L000	without standard connecting cable	not with transmitter N not with design and housing 0, 2 not with option MC_
	L005	5 meter (16.4 ft) remote connecting cable terminated std. gray / Ex blue	
	L010	10 meter (32.8 ft) remote connecting cable terminated std. gray / Ex blue	
	L015	15 meter (49.2 ft) remote connecting cable terminated std. gray / Ex blue	
	L020	20 meter (65.6 ft) remote connecting cable terminated std. gray / Ex blue	
	L030	30 meter (98.4 ft) remote connecting cable terminated std. gray / Ex blue	
Connecting cable type and length	Y000	without fire retardant connecting cable	not with design and housing 0, 2; not with Ex approval FF_-, JF5_
	Y005	5 meter (16.4 ft) remote fire retardant connecting cable not terminated	not with transmitter N not with design and housing 0, 2; not with Ex approval FF_-, JF5_
	Y010	10 meter (32.8 ft) remote fire retardant connecting cable not terminated	
	Y015	15 meter (49.2 ft) remote fire retardant connecting cable not terminated	
	Y020	20 meter (65.6 ft) remote fire retardant connecting cable not terminated	
	Y030	30 meter (98.4 ft) remote fire retardant connecting cable not terminated	
Marine Approval	MC2	Marine approval according to DNV GL piping class 2	not with transmitter N, design and housing 0, 2, communication type and I/O JP, JQ, JR, JS, G_
	MC3	Marine approval according to DNV GL piping class 3	not with option V5_ only with option Y_... in case of thermal oil applications option RT or RTA is mandatory
Batching function	BT	Batching and filling function	only with transmitter U and communication type and I/O J_
Viscosity function	VM	Viscosity computing function for liquids	only with transmitter U not with mass flow and density accuracy 70, 50 only with communication type and I/O JH, JJ, JK, JL, JM, JN, G_

Option category	Options	Description	Restriction
Sanitary options	SF2	Surface Roughness wetted parts $R_a \leq 0.8 \mu\text{m}$ and Surface Roughness Inspection Certificate	–
	SA	3-A product conformity with 3-A certificate and marking, including Surface Roughness wetted parts $R_a \leq 0.8 \mu\text{m}$ and Surface Roughness Inspection Certificate	not with design and housing J
	SE	EHEDG product conformity with EHEDG certificate and marking, including Surface Roughness wetted parts $R_a \leq 0.8 \mu\text{m}$ and Surface Roughness Inspection Certificate	for meter size 80 not with process connection size 50
Combined certificate	P10	Combination of: <ul style="list-style-type: none"> ▪ P3: Quality Inspection Certificate ▪ P6: Certificate of Marking Transfer and Raw Material Certificates ▪ P8: Hydrostatic Pressure Test Certificate 	not with option P3, P6, P8
	P11	Combination of: <ul style="list-style-type: none"> ▪ P3: Quality Inspection Certificate ▪ P6: Certificate of Marking Transfer and Raw Material Certificates ▪ PM: Positive Material Identification of wetted parts 	not with option P3, P6, PM
	P12	Combination of: <ul style="list-style-type: none"> ▪ P3: Quality Inspection Certificate ▪ P6: Certificate of Marking Transfer and Raw Material Certificates ▪ PT: Dye penetrant test according to DIN EN ISO 3452-1 ▪ P8: Hydrostatic Pressure Test Certificate 	not with option P3, P6, P8, WP, PT
	P13	Combination of: <ul style="list-style-type: none"> ▪ P3: Quality Inspection Certificate ▪ P6: Certificate of Marking Transfer and Raw Material Certificates ▪ PT: Dye penetrant test according to DIN EN ISO 3452-1 ▪ PM: Positive Material Identification of wetted parts ▪ P8: Hydrostatic Pressure Test Certificate ▪ WP: Welding certificates 	not with option P3, P6, P8, WP, PM, PT
	P14	Combination of: <ul style="list-style-type: none"> ▪ PM: Positive Material Identification of wetted parts ▪ P8: Hydrostatic Pressure Test Certificate ▪ WP: Welding certificates 	not with option P8, WP, PM
Cable glands and blind plug	V52	2 cable glands, 1 blind plug for power, communication and I/O	not with transmitter N only with Ex approval JF5_
	V53	3 cable glands for power, communication and I/O	not with MC_

10.6 Model code

The model code of the Rotamass Total Insight is explained below.

Items 1 through 14 are mandatory entries and must be specified at the time of ordering.

Device options (item 15) can be selected and specified individually by separating them with slashes.

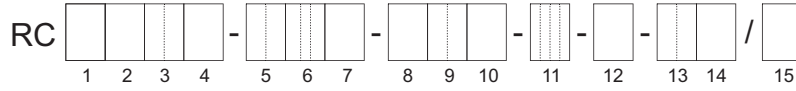

- 1 Transmitter
- 2 Sensor
- 3 Meter size
- 4 Material wetted parts
- 5 Process connection size
- 6 Process connection type
- 7 Sensor housing material
- 8 Process fluid temperature range
- 9 Mass flow and density accuracy
- 10 Design and housing
- 11 Ex approval
- 12 Cable entries
- 13 Communication type and I/O
- 14 Display
- 15 Options

10.6.1 Transmitter

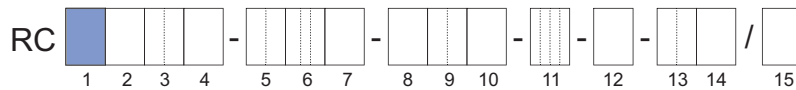

Model code position 1	Transmitter
E	Essential (base function)
U	Ultimate (high function)
N	Spare sensor without transmitter, combinable with Rotamass Total Insight transmitter

10.6.2 Sensor

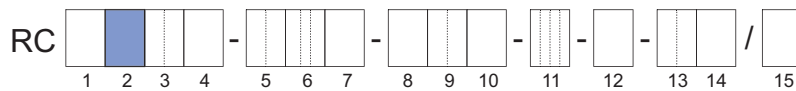

Model code position 2	Sensor
H	Hygienic

10.6.3 Meter size

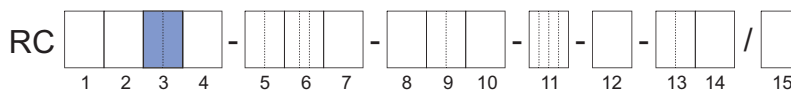

Model code position 3	Meter size	Nominal mass flow in t/h (lb/min)	Maximum mass flow in t/h (lb/min)
25	25	1.6 (59)	2.3 (85)
40	40	4.7 (170)	7 (260)
50	50	20 (730)	29 (1100)
80	80	51 (1900)	76 (2800)

10.6.4 Material wetted parts

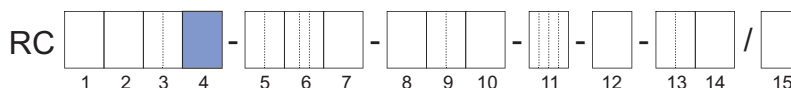

Model code position 4	Material wetted parts
S	Stainless steel 1.4404/316L

10.6.5 Process connection size

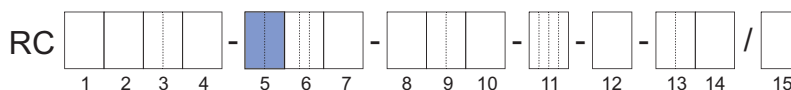

Model code position 5	Process connection size
25	DN25, 1"
40	DN40, 1½"
50	DN50, 2"
65	DN65, 2½"
80	DN80, 3"



Available sizes depend on the actual process connection, see also chapter *Process connections, dimensions and weights of sensor* [44].

10.6.6 Process connection type

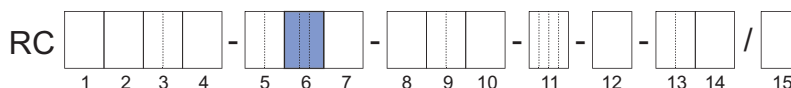

Model code position 6	Type	Process connections
HS2	Threaded connections	Threaded connection according to DIN 11851
HS4	Clamp connections	Clamp process connection according to DIN 32676 series A
HS8		Clamp process connection according to DIN 32676 series C (Tri-Clamp)
HS9		Clamp process connection according to JIS G3447 / ISO 2852

10.6.7 Sensor housing material

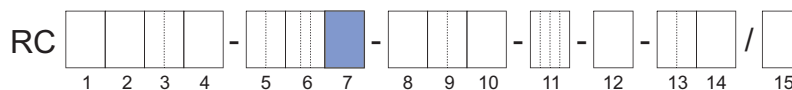

Model code position 7	Housing material
0	Stainless steel 1.4301/304, 1.4404/316L

10.6.8 Process fluid temperature range

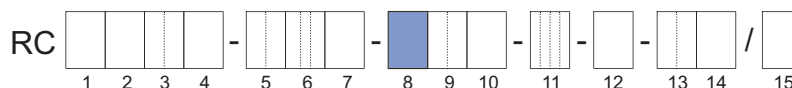

Model code position 8	Temperature range	Process fluid temperature range
0	Standard	Integral type: -50 – 140 °C (-58 – 284 °F) Remote type: -70 – 140 °C (-94 – 284 °F)

For temperature range limits, see chapter *Process fluid temperature range* [▶ 28].

10.6.9 Mass flow and density accuracy

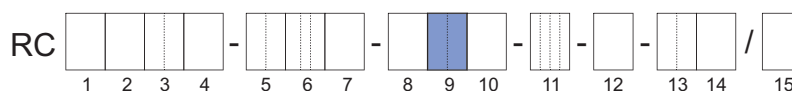

Model code position 9	Fluid	Maximum deviation	
		Mass flow D_{flat} in %	Density in g/l
E7	Liquid	0.2	4
D7		0.15	4
C7		0.1	4
C3		0.1	1
C2			0.5
70	Gas	0.75	–
50		0.5	–

Devices with value _2 in model code position 9 receive an additional density calibration with a corresponding certificate.

10.6.10 Design and housing

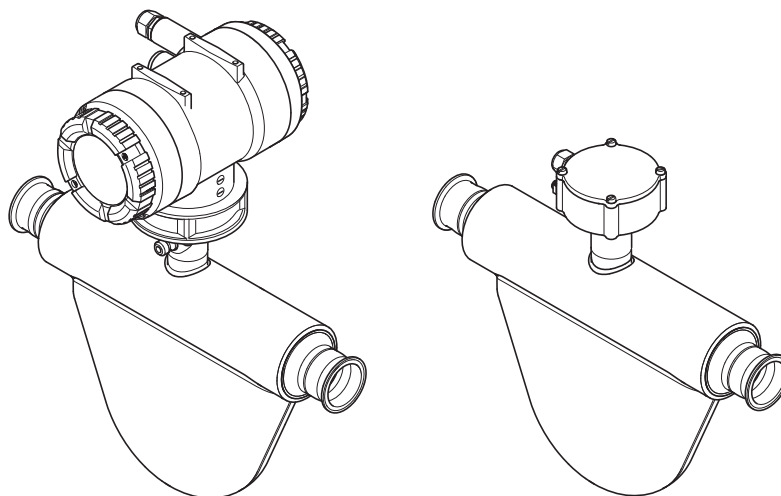
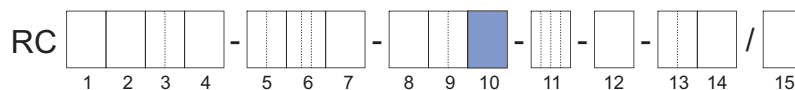

Model code position 10	Design type	Transmitter housing material	Transmitter housing coating	Sensor terminal box material
0	Integral type	Aluminum	Standard coating	-
2			Corrosion protection coating	
A	Remote type	Aluminum	Standard coating	Stainless steel
E			Corrosion protection coating	
J	Remote type	Stainless Steel	-	Stainless steel

The remote type requires a connecting cable to connect sensor and transmitter. It can be selected in various lengths as a device option, see *Connecting cable type and length* [▶ 111].

10.6.11 Ex approval

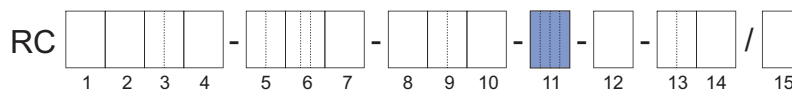

Model code position 11	Ex approval
NN00	None
KF21	ATEX, explosion group IIC and IIIC
KF22	ATEX, explosion group IIB and IIIC
SF21	IECEX, explosion group IIC and IIIC
SF22	IECEX, explosion group IIB and IIIC
FF11	FM, group A, B, C, D, E, F, G
FF12	FM, group C, D, E, F, G
GF21	EAC Ex, explosion group IIC and IIIC
GF22	EAC Ex, explosion group IIB and IIIC
UF21	INMETRO, explosion group IIC and IIIC
UF22	INMETRO, explosion group IIB and IIIC
NF21	NEPSI, explosion group IIC and IIIC
NF22	NEPSI, explosion group IIB and IIIC
PF21	Korea Ex, explosion group IIC and IIIC
PF22	Korea Ex, explosion group IIB and IIIC
JF53	Japan Ex, Temperature class T3, explosion group IIC
JF54	Japan Ex, Temperature class T4, explosion group IIC

10.6.12 Cable entries

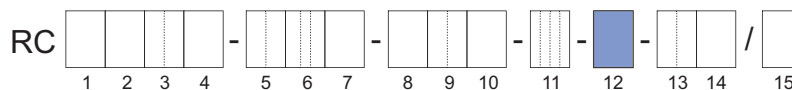

Model code position 12	Cable entries
2	ANSI 1/2" NPT
4	ISO M20x1.5

10.6.13 Communication type and I/O

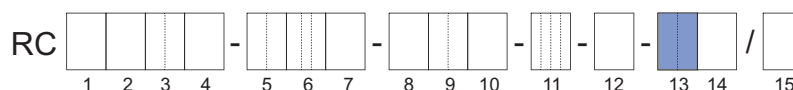

HART I/O

Model code position 13	Connection terminal assignment				
	I/O1 +/-	I/O2 +/-	I/O3 +/-	I/O4 +/-	WP
JA	lout1 Active	P/Sout1 Passive	–	–	Write-protect
JB	lout1 Active	P/Sout1 Passive	P/Sout2 Passive	lout2 Active	Write-protect
JC	lout1 Active	P/Sout1 Passive	Sin	lout2 Active	Write-protect
JD	lout1 Active	P/Sout1 Passive	Sout Passive	P/Sout2 Passive	Write-protect
JE	lout1 Active	P/Sout1 Passive	Sin	P/Sout2 Passive	Write-protect
JF	lout1 Active	P/Sout1 Passive	Sin	P/Sout2 Active Internal pull-up resistor	Write-protect
JG	lout1 Active	P/Sout1 Passive	Sin	P/Sout2 Active	Write-protect
JH	lout1 Active	P/Sout1 Passive	lout2 Passive	lin Active	Write-protect
JJ	lout1 Active	P/Sout1 Passive	P/Sout2 Passive	lin Active	Write-protect
JK	lout1 Active	P/Sout1 Passive	Sin	lin Active	Write-protect
JL	lout1 Active	P/Sout1 Passive	lout2 Passive	lin Passive	Write-protect
JM	lout1 Active	P/Sout1 Passive	P/Sout2 Passive	lin Passive	Write-protect
JN	lout1 Active	P/Sout1 Passive	Sin	lin Passive	Write-protect

lout1 Analog current output with HART communication
 lout2 Analog current output
 lin Analog current input
 P/Sout1 Pulse or status output
 P/Sout2 Pulse or status output
 Sin Status input
 Sout Status output

**HART I/O,
intrinsically safe**

Model code position 13	Connection terminal assignment				
	I/O1 +/-	I/O2 +/-	I/O3 +/-	I/O4 +/-	WP
JP	lout1 Passive	P/Sout1 Passive	lout2 Passive	–	Write-protect
JQ	lout1 Passive	P/Sout1 Passive	lout2 Passive	P/Sout2 Passive	Write-protect
JR	lout1 Passive	P/Sout1 Passive NAMUR	lout2 Passive	–	Write-protect
JS	lout1 Passive	P/Sout1 Passive NAMUR	lout2 Passive	P/Sout2 Passive NAMUR	Write-protect

lout1 Analog current output with HART communication

lout2 Analog current output

P/Sout1 Pulse or status output

P/Sout2 Pulse or status output

Intrinsically safe outputs are only available in combination with selecting Ex approval of the device, see chapter Ex approval.

Modbus I/O

Model code position 13	Connection terminal assignment						
	I/O1 +/-	I/O2 +/-	I/O3 +	I/O3 -	I/O4 +	I/O4 -	WP
M0	–	P/Sout1 Passive	–	Modbus C	Modbus B	Modbus A	Write- protect
M2	lin Active	P/Sout1 Passive	–	Modbus C	Modbus B	Modbus A	Write- protect
M3	P/Sout2 Passive	P/Sout1 Passive	–	Modbus C	Modbus B	Modbus A	Write- protect
M4	P/Sout2 Active	P/Sout1 Passive	–	Modbus C	Modbus B	Modbus A	Write- protect
M5	P/Sout2 Active Internal pull-up resistor	P/Sout1 Passive	–	Modbus C	Modbus B	Modbus A	Write- protect
M6	lout1 Active	P/Sout1 Passive	–	Modbus C	Modbus B	Modbus A	Write- protect
M7	lin Passive	P/Sout1 Passive	–	Modbus C	Modbus B	Modbus A	Write- protect

lout Analog current output, no HART

lin Analog current input

P/Sout1 Pulse or status output

P/Sout2 Pulse or status output

PROFIBUS PA

Model code position 13	Connection terminal assignment				
	I/O1 +/-	I/O2 +/-	I/O3 +/-	I/O4 +/-	WP
G0	PROFIBUS PA	Pulse Passive	–	–	Write-protect
G1	PROFIBUS PA (IS)	Pulse Passive (IS)	–	–	Write-protect

PROFIBUS PA PA communication
 Pulse Passive Pulse / Frequency output

Intrinsically safe (IS) outputs are only available in combination with selecting Ex approval of the device, see chapter Ex approval.

Spare sensor I/O

Model code position 13	Specification
NN	Spare sensor without transmitter, all communication types and I/Os apply

10.6.14 Display

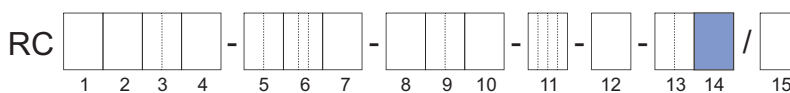

The display unit includes a slot for the microSD card.

Model code position 14	Display
0	Without display
1	With display
N	Spare sensor without transmitter, no display applied

Devices without a display are available for Essential transmitters only (value E in model code position 1).

10.7 Options

Additional device options that can be combined may be selected; they are listed sequentially in model code position 15. In this case, each device option is preceded by a slash.

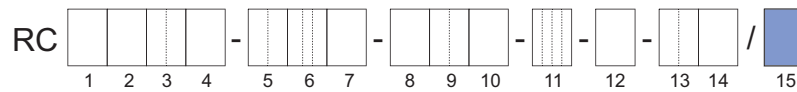

The following device options are possible:

- Connecting cable length, see chapter *Connecting cable type and length* [▶ 111].
- Customer-specific adaptation of the nameplate, see chapter *Additional nameplate information* [▶ 111].
- Flow meter presetting with customer parameters, see chapter *Presetting of customer parameters* [▶ 111].
- Concentration and petroleum measurement, see chapter *Concentration and petroleum measurement* [▶ 112].
- Batching function, see chapter *Batching function* [▶ 112].
- Viscosity function, see chapter *Viscosity function* [▶ 112].
- Certificates to be supplied, see chapter *Certificates* [▶ 113].
- Country-specific delivery *Country-specific delivery* [▶ 115].
- Country-specific application *Country-specific application* [▶ 115].
- Tube Health Check, see chapter *Tube Health Check* [▶ 115].
- Transmitter housing rotated 180°, see chapter *Transmitter housing rotated 180°* [▶ 116].
- Measurement of heat quantity, see chapter *Measurement of heat quantity* [▶ 116].
- Marine type approval, see chapter *Marine approval* [▶ 116].
- Sanitary options, see chapter *Sanitary options* [▶ 117].
- Cable glands and blind plug, see chapter *Cable glands and blind plug* [▶ 117].

10.7.1 Connecting cable type and length

When ordering the remote type it is mandatory to select one of the below shown connecting cable lengths.

It is possible to order cables with higher length than the maximum cable length and termination kits separately. For this purpose please check the "Customers Maintenance Parts List" (Ref.: CMPL 01U10B00-00EN-R) or consult our Yokogawa Service team.

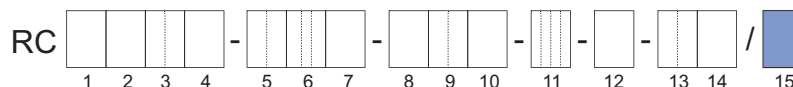

Options	Specification
L000	without standard connecting cable ¹⁾
L005	5 meter (16.4 ft) remote connecting cable terminated std. gray / Ex blue
L010	10 meter (32.8 ft) remote connecting cable terminated std. gray / Ex blue
L015	15 meter (49.2 ft) remote connecting cable terminated std. gray / Ex blue
L020	20 meter (65.6 ft) remote connecting cable terminated std. gray / Ex blue
L030	30 meter (98.4 ft) remote connecting cable terminated std. gray / Ex blue
Y000	without fire retardant connecting cable ¹⁾
Y005	5 meter (16.4 ft) remote fire retardant connecting cable, not terminated
Y010	10 meter (32.8 ft) remote fire retardant connecting cable, not terminated
Y015	15 meter (49.2 ft) remote fire retardant connecting cable, not terminated
Y020	20 meter (65.6 ft) remote fire retardant connecting cable, not terminated
Y030	30 meter (98.4 ft) remote fire retardant connecting cable, not terminated

¹⁾ Even without cables, it is necessary to select this option, because the device name plate shows the allowed ambient temperature depending on the selected cable type (see chapter [33]).

Fire retardant cable is mandatory for DNV GL type approval (options MC2 and MC3). The minimum permissible ambient temperature for the two cable types differs (see chapter *Allowed ambient temperature for sensor* [33]). The cable type intended to be used needs to be indicated (with option L000 or Y000) even if connecting cable is ordered separately.

10.7.2 Additional nameplate information

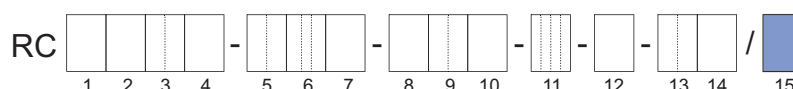

Options	Specification
BG	Nameplate with customer device location identification

This marking (Tag No.) must be provided by the customer at the time the order is placed.

10.7.3 Presetting of customer parameters

Rotamass flow meters can be preconfigured with customer-specific data.



Options	Specification
PS	Presetting according to customer parameters.

10.7.4 Concentration and petroleum measurement

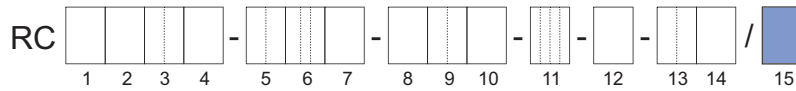

Options	Specification
CST	Standard concentration measurement
AC0	Advanced concentration measurement, customer settings
AC1	Advanced concentration measurement, one default data set
AC2	Advanced concentration measurement, two default data sets
AC3	Advanced concentration measurement, three default data sets
AC4	Advanced concentration measurement, four default data sets

These device options are not available in combination with gas measurement devices (model code position 9 with the values: 70 or 50).

Options with CST, AC_ are available only for Ultimate transmitters (value U in model code position 1).

Advanced concentration function can be ordered with 1 to 4 different sets of pre-configured concentrations (AC1 – AC4).

For details about the device function refer to *Concentration and petroleum measurement* [▶ 66].

10.7.5 Batching function

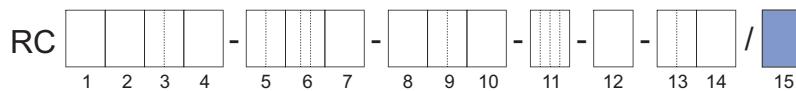

Options	Specification
BT	Batching and filling function

For details about the device function refer to *Batching function* [▶ 67].

10.7.6 Viscosity function

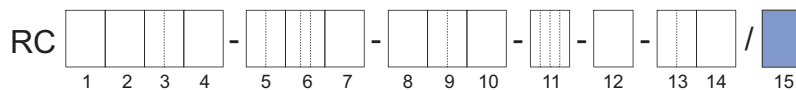

Options	Specification
VM	Viscosity computing function for liquids

For details about the device function refer to *Viscosity function* [▶ 68].

10.7.7 Enhanced process temperature (Explosion proof)

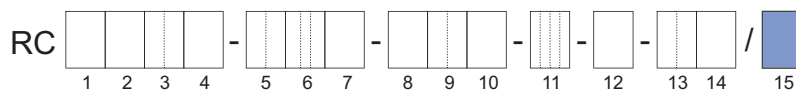

Options	Specification
EPT	Expanded process fluid temperature range for temperature classes T6, T5, T4 and T3 for hazardous areas

- For details of temperature specification of temperature classes compare temperature classification in *Temperature specification in hazardous areas* [▶ 35].

10.7.8 Certificates

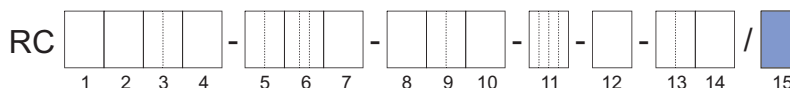
Accordance with terms of order

Options	Specification
P2	Declaration of compliance with the order 2.1 according to EN 10204
P3	Quality Inspection Certificate (Inspection Certificate 3.1 according to EN 10204)

Material certificates

Options	Specification
P6	Certificate of Marking Transfer and Raw Material Certificates (Inspection Certificate 3.1 according to EN 10204), including IGC and conform to NACE MR0175 and MR0103

For details and exceptions please refer to Rota Yokogawa declaration about NACE conformity, document no. 8660001.

Dye penetrant test of weld seams

Options	Specification
PT	Dye penetrant test of process connection weld seams according to DIN EN ISO 3452-1, including certificate

Positive Material Identification of wetted parts

Options	Specification
PM	Positive Material Identification of wetted parts, including certificate (Inspection Certificate 3.1 according to EN 10204)

Pressure testing

Options	Specification
P8	Hydrostatic Pressure Test Certificate (Inspection Certificate 3.1 according to EN 10204)

Welding certificates

Options	Specification
WP	Welding certificates: <ul style="list-style-type: none"> ▪ WPS according to DIN EN ISO 15609-1 ▪ WPQR according to DIN EN ISO 15614-1 ▪ WQC according to DIN EN 287-1 or DIN EN ISO 6906-4

Only for the butt welding seam between the process connection and the flow divider.

Mass flow calibration

Options	Specification
K2	Customer-specific 5-point mass flow calibration with measuring range on factory calibration certificate (mass flow or volume flow of water). A table listing the desired calibration points must be supplied with the order.
K5	Customer-specific 10-point mass flow calibration with measuring range on DAkkS calibration certificate (mass flow or volume flow of water). A table listing the desired calibration points must be supplied with the order.

Water is used as fluid for calibrating the Rotamass.

Calibration certificates

Options	Specification
L2	The certificate confirms that the delivered instrument has undergone a calibration traceable to national standards, including a list of working standards used for calibration. Language: English/Japanese
L3	The certificate confirms that the delivered instrument has undergone a calibration traceable to national standards, including a list of primary standards to which the delivered product is traceable. Language: English/Japanese
L4	The certificate confirms that the delivered instrument has undergone a calibration traceable to national standards and that the calibration system of Rota Yokogawa is traceable to national standards. Language: English/Japanese

Surfaces free of oil and grease

Options	Specification
H1	Degreasing of wetted surfaces according to ASTM G93-03 (Level C), including test report

X-ray inspection of process connection weld seam

Options	Specification
RT	X-ray inspection of process connection weld seam according to DIN EN ISO 17636-1/B Evaluation according to AD 2000 HP 5/3 and DIN EN ISO 5817/C, including certificate

Combined certificates

Options	Specification
P10	Combination of: <ul style="list-style-type: none"> ▪ P3: Quality Inspection Certificate ▪ P6: Certificate of Marking Transfer and Raw Material Certificates ▪ P8: Hydrostatic Pressure Test Certificate
P11	Combination of: <ul style="list-style-type: none"> ▪ P3: Quality Inspection Certificate ▪ P6: Certificate of Marking Transfer and Raw Material Certificates ▪ PM: Positive Material Identification of wetted parts
P12	Combination of: <ul style="list-style-type: none"> ▪ P3: Quality Inspection Certificate ▪ P6: Certificate of Marking Transfer and Raw Material Certificates ▪ PT: Dye penetrant test according to DIN EN ISO 3452-1 ▪ P8: Hydrostatic Pressure Test Certificate
P13	Combination of: <ul style="list-style-type: none"> ▪ P3: Quality Inspection Certificate ▪ P6: Certificate of Marking Transfer and Raw Material Certificates ▪ PT: Dye penetrant test according to DIN EN ISO 3452-1 ▪ PM: Positive Material Identification of wetted parts ▪ P8: Hydrostatic Pressure Test Certificate ▪ WP: Welding certificates
P14	Combination of: <ul style="list-style-type: none"> ▪ PM: Positive Material Identification of wetted parts ▪ P8: Hydrostatic Pressure Test Certificate ▪ WP: Welding certificates

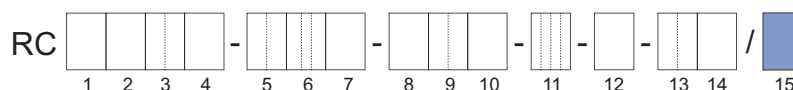
10.7.9 Country-specific delivery

Options	Specification
PJ	Delivery to Japan incl. SI units pre-setting and Quality Inspection Certificate (EN/JP)
CN	Delivery to China including China RoHS mark
KC	Delivery to Korea including KC mark
VE	Delivery to EAEU area including EAC mark
VB	Delivery to EAEU area including EAC mark and Belarus Pattern Approval mark
VR ¹⁾	Delivery to EAEU area including EAC mark and Russia Pattern Approval mark

¹⁾ In case of combination with option TC the Dry Verification is available for the Russian Pattern Approval, which allows to check the continuation of the accuracy of the Rotamass.

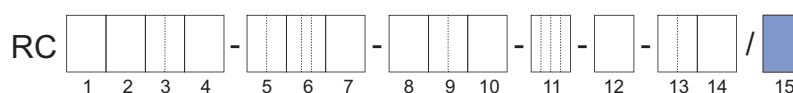
10.7.10 Country-specific application

Options	Specification
Q11	PESO approval delivery
QR	Primary calibration valid in Russia, including certificate

10.7.11 Tube Health Check

By way of the Tube Health Check, the transmitter can determine whether the tube properties were altered due to corrosion or deposits and whether they could impact accuracy as a result.

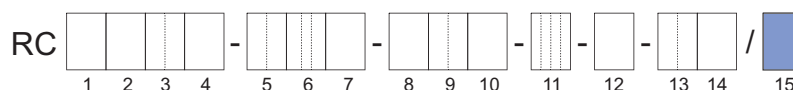

Options	Specification
TC	Tube Health Check

10.7.12 Transmitter housing rotated 180°

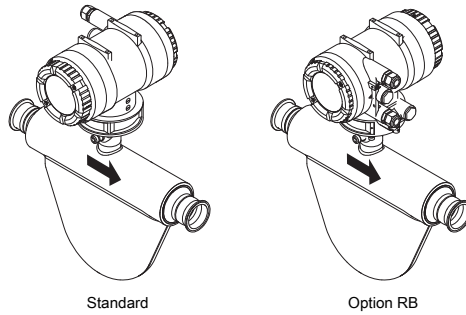
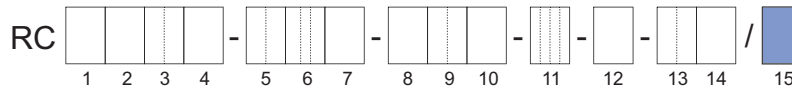

Options	Specification
RB	Alignment of transmitter housing rotated 180°

10.7.13 Measurement of heat quantity

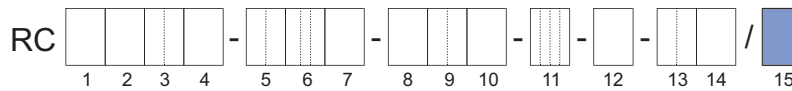

Options	Specification
CGC	Measurement of the total transported energy content of a fuel in connection with a sensor for determining the fuel's calorific value (e.g. a gas chromatograph, not included in scope of delivery). This option is available only together with model code position 13 JH to JN.

For details about the device function refer to *Measurement of heat quantity* [▶ 69].

10.7.14 Marine approval

By ordering options MC2 and MC3 the device will carry a type approval mark by DNV GL. Ordering of fire retardant cable (Y_...) is mandatory with this option. In case of thermal oil applications option RT or RTA is mandatory. Please note that DNV GL has additional requirements regarding the process conditions as reproduced in the table below. The complete requirements can be found in the classification society's rules concerning the respective use case. Marine approval is not available for all device variants, for details see exclusions in *Overview options* [▶ 98].

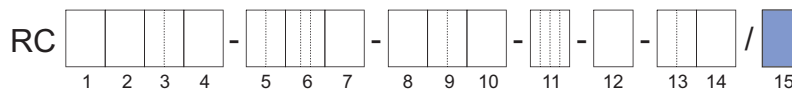

Options	Specification
MC2	Marine approval according to DNV GL piping class 2
MC3	Marine approval according to DNV GL piping class 3

Piping system for	Option			
	MC2		MC3	
	Class II ¹⁾		Class III ¹⁾	
	p in bar	T _D in °C	p in bar	T _D in °C
Steam	≤ 16	≤ 300	≤ 7	≤ 170
Thermal oil	≤ 16	≤ 300	≤ 7	≤ 150
Fuel oil, lubricating oil, flammable oil	≤ 16	≤ 150	≤ 7	≤ 60
Other media ²⁾	≤ 40	≤ 300	≤ 16	≤ 200

p : Design pressure

T_D : Design temperature

¹⁾ both specified conditions (p and T_D) shall be met

²⁾ Cargo oil pipes on oil carriers and open ended pipes (drain overflows, vents, boiler escape pipes etc.) independently of the pressure and temperature, are pertaining to class III.

10.7.15 Sanitary options

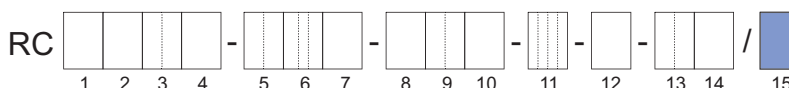

Options	Specification
SF2	Surface Roughness wetted parts R _a ≤ 0.8 μm and Surface Roughness Inspection Certificate
SA	3-A product conformity with 3-A certificate and marking, including Surface Roughness wetted parts R _a ≤ 0.8 μm and Surface Roughness Inspection Certificate
SE	EHEDG product conformity with EHEDG certificate and marking, including Surface Roughness wetted parts R _a ≤ 0.8 μm and Surface Roughness Inspection Certificate

10.7.16 Cable glands and blind plug

For Japan Ex Approval JF5_ following flame proof cable glands have to be ordered.

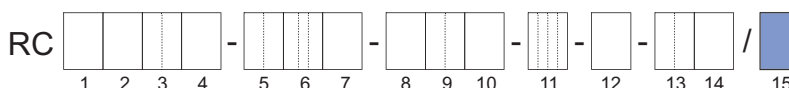

Options	Specification
V52	2 cable glands, 1 blind plug for power, communication and I/O
V53	3 cable glands for power, communication and I/O

10.7.17 Customer-specific special product manufacture

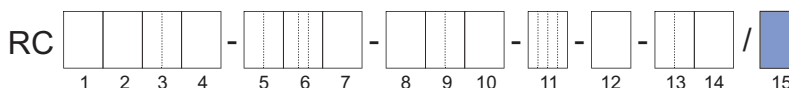

Options	Specification
Z	Deviations from the specifications in this document are possible.

10.8 Ordering Instructions

Specify the following information when ordering a product:

- Model code
- Fluid name
- Language of the quick reference instruction manual paper version:
 - English
 - French
 - German
 - Japanese
 - Chinese
 - Korean
 - Russian
- Display language and language pack (display only present for value 1 on position 14 of the model code):

pack 1	pack 2	pack 3
EN-Pack1 - English	EN-Pack2 - English	EN-Pack3 - English
DE-Pack1 - German	DE-Pack2 - German	DE-Pack3 - German
FR-Pack1 - French	RU-Pack2 - Russian	FR-Pack3 - French
PT-Pack1 - Portuguese	PL-Pack2 - Polish	PT-Pack3 - Portuguese
IT-Pack1 - Italian	KZ-Pack2 - Kazakh	IT-Pack3 - Italian
ES-Pack1 - Spanish		ES-Pack3 - Spanish
JA-Pack1 - Japanese		CN-Pack3 - Chinese

- Unit notation on the display (display only present for value 1 on position 14 of the model code):
 - Metric units
 - Imperial units - US
 - Imperial units - GB
 - Russia specific units (only available with language pack 2)
 - Japan specific units (only available with language pack 1)
- Orientation of the display (display only present for value 1 on position 14 of the model code):

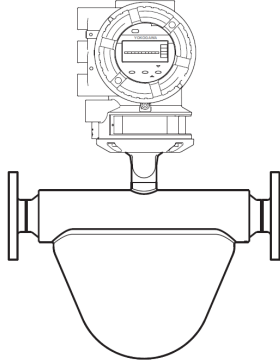
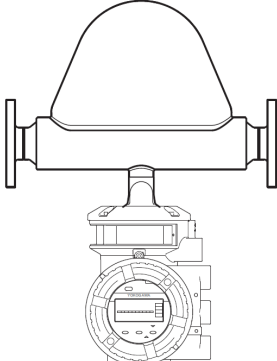
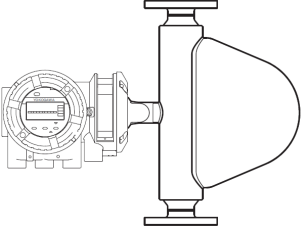
	Orientation 1	Orientation 2	Orientation 3
Integral type	Horizontal installation - tubes down 	Horizontal installation - tubes up 	Vertical installation 

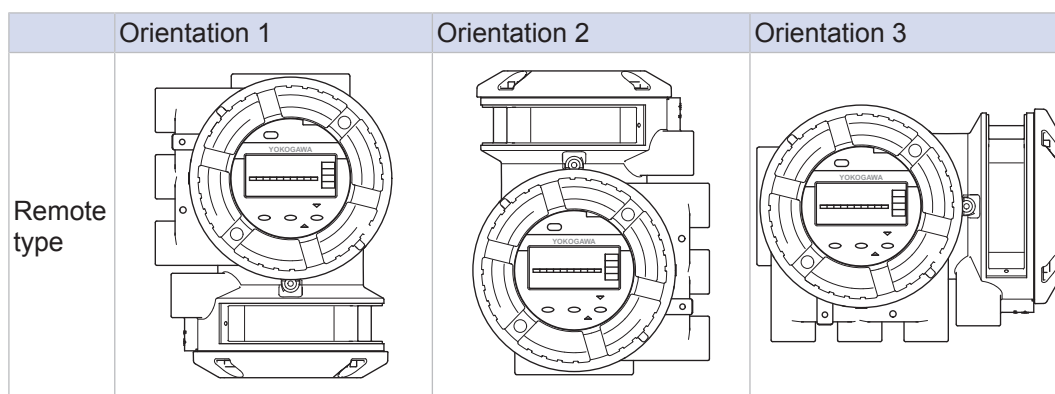

In the above the figure, the case of the Prime sensor is shown. The design of sensor depend on the each series.



The parameter "Installation Orientation" in transmitter must be set by the customer according to the installation direction of the sensor.

- Tag No. engraved on the nameplate and mentioned on the calibration certificate (option BG, up to 16 characters length)
- Software Tag No.: short and long (short tag no. mentioned also on the calibration certificate):

Parameter	Value
HART Tag No. (short): up to 8 characters length (Capital letters only)	Default value has 8 space characters
HART Tag No. (long): up to 32 characters length	Default value has 32 space characters
PROFIBUS PA NODE ADDRESS (HEX): up to 4 characters length	Default value '0x7E' unless otherwise specified
PROFIBUS PA SOFTWARE TAG: up to 32 characters length	Default value 'FT2001' unless otherwise specified

- Customer name for the certificates (option L2, L3, L4: up to 60 characters length)
- Advanced concentration type (option AC1 – AC4, see Concentration measurement):
 - C01 Sugar / Water 0 – 85 °Bx, 0 – 80 °C
 - C02 NaOH / Water 2 – 50 WT%, 0 – 100 °C
 - C03 KOH / Water 0 – 60 WT%, 54 – 100 °C
 - C04 NH4NO3 / Water 1 – 50 WT%, 0 – 80 °C
 - C05 NH4NO3 / Water 20 – 70 WT%, 20 – 100 °C
 - C06 HCl / Water 22 – 34 WT%, 20 – 40 °C
 - C07 HNO3 / Water 50 – 67 WT%, 10 – 60 °C
 - C09 H2O2 / Water 30 – 75 WT%, 4 – 44 °C
 - C10 Ethylene Glycol / Water 10 – 50 WT%, -20 – 40 °C
 - C11 Amylum = starch / Water 33 – 43 WT%, 35 – 45 °C
 - C12 Methanol / Water 35 – 60 WT%, 0 – 40 °C
 - C20 Alcohol / Water 55 – 100 VOL%, 10 – 40 °C
 - C21 Sugar / Water 40 – 80 °Bx, 75 – 100 °C
 - C30 Alcohol / Water 66 – 100 WT%, 15 – 40 °C
 - C37 Alcohol / Water 66 – 100 WT%, 10 – 40 °C

TRADEMARKS

HART:	registered trademark of FieldComm Group, Inc., US
Modbus:	registered trademark of SCHNEIDER ELECTRIC USA, INC.
PROFIBUS:	registered trademark of PROFIBUS Nutzerorganisation e.V., Karlsruhe, DE
TRI-CLAMP:	registered trademark of ALFA LAVAL CORPORATE AB, SE
ROTAMASS:	registered trademark of Rota Yokogawa GmbH & Co. KG, DE
FieldMate:	registered trademark of YOKOGAWA ELECTRIC CORPORATION

All other company and product names mentioned in this document are trade names, trademarks or registered trademarks of their respective companies. In this document, trademarks or registered trademarks are not marked with TM or ®.

All rights reserved. Copyright © 2019-07-01

<p>YOKOGAWA ELECTRIC CORPORATION Headquarters 2-9-32, Nakacho, Musashino-shi, Tokyo, 180-8750 JAPAN Phone : 81-422-52-5555 Branch Sales Offices Osaka, Nagoya, Hiroshima, Kurashiki, Fukuoka, Kitakyusyu</p>	<p>YOKOGAWA ELECTRIC CIS LTD. Grokholskiy per 13 Building 2, 4th Floor 129090, Moscow, RUSSIA Phone : 7-495-737-7868 Fax : 7-495-737-7869</p>	<p>YOKOGAWA INDIA LTD. Plot No.96, Electronic City Complex, Hosur Road, Bangalore - 560 100, INDIA Phone : 91-80-4158-6000 Fax : 91-80-2852-1442</p>
<p>YOKOGAWA CORPORATION OF AMERICA Head Office 12530 West Airport Blvd, Sugar Land, Texas 77478, USA Phone : 1-281-340-3800 Fax : 1-281-340-3838 Georgia Office 2 Dart Road, Newnan, Georgia 30265, USA Phone : 1-800-888-6400/ 1-770-253-7000 Fax : 1-770-254-0928</p>	<p>YOKOGAWA CHINA CO., LTD. 3F Tower D, No.568 West Tianshan RD. Shanghai CHINA, 200335 Phone : 86-21-62396262 Fax : 86-21-62387866</p>	<p>YOKOGAWA AUSTRALIA PTY. LTD. Tower A, 112-118 Talavera Road, Macquarie Park NSW 2113, AUSTRALIA Phone : 61-2-8870-1100 Fax : 61-2-8870-1111</p>
<p>YOKOGAWA AMERICA DO SUL LTDA. Praca Acapulco, 31 - Santo Amaro, São Paulo/SP, BRAZIL, CEP-04675-190 Phone : 55-11-5681-2400 Fax : 55-11-5681-4434</p>	<p>YOKOGAWA ELECTRIC KOREA CO., LTD. (Yokogawa B/D, Yangpyeong-dong 4-Ga), 21, Seonyu-ro 45-gil, Yeongdeungpo-gu, Seoul, 150-866, KOREA Phone : 82-2-2628-6000 Fax : 82-2-2628-6400</p>	<p>YOKOGAWA MIDDLE EAST & AFRICA B.S.C.(C) P.O. Box 10070, Manama, Building 577, Road 2516, Busaiteen 225, Muharra, Kingdom of SAUDI ARABIA Phone : 973-17358100 Fax : 973-17336100</p>
<p>YOKOGAWA EUROPE B. V. Euroweg 2, 3825 HD Amersfoort, THE NETHERLANDS Phone : 31-88-4641000 Fax : 31-88-4641111</p>	<p>YOKOGAWA ENGINEERING ASIA PTE. LTD. 5 Bedok South Road, Singapore 469270, SINGAPORE Phone : 65-6241-9933 Fax : 65-6241-2606</p>	<p> YOKOGAWA ◆</p> <p><small>ISO 9001</small></p>